

ARC-10W33

10.1" Intel® Pentium®/Celeron®/Atom™ SoC Processor
Apollo Lake Fanless Rugged Touch Panel PC with IET
Expansion

Quick Reference Guide

3rd Ed – 13 August 2020

Copyright Notice

Copyright © 2020 Avalue Technology Inc., ALL RIGHTS RESERVED.

Part No. E2017A031A2R

FCC Statement



THIS DEVICE COMPLIES WITH PART 15 FCC RULES. OPERATION IS SUBJECT TO THE FOLLOWING TWO CONDITIONS:

(1) THIS DEVICE MAY NOT CAUSE HARMFUL INTERFERENCE.

(2) THIS DEVICE MUST ACCEPT ANY INTERFERENCE RECEIVED INCLUDING INTERFERENCE THAT MAY CAUSE UNDESIRE OPERATION.

THIS EQUIPMENT HAS BEEN TESTED AND FOUND TO COMPLY WITH THE LIMITS FOR A CLASS "A" DIGITAL DEVICE, PURSUANT TO PART 15 OF THE FCC RULES.

THESE LIMITS ARE DESIGNED TO PROVIDE REASONABLE PROTECTION AGAINST HARMFUL INTERFERENCE WHEN THE EQUIPMENT IS OPERATED IN A COMMERCIAL ENVIRONMENT. THIS EQUIPMENT GENERATES, USES, AND CAN RADIATE RADIO FREQUENCY ENERGY AND, IF NOT INSTALLED AND USED IN ACCORDANCE WITH THE INSTRUCTION MANUAL, MAY CAUSE HARMFUL INTERFERENCE TO RADIO COMMUNICATIONS.

OPERATION OF THIS EQUIPMENT IN A RESIDENTIAL AREA IS LIKELY TO CAUSE HARMFUL INTERFERENCE IN WHICH CASE THE USER WILL BE REQUIRED TO CORRECT THE INTERFERENCE AT HIS OWN EXPENSE.

A Message to the Customer

Avalue Customer Services

Each and every Avalue's product is built to the most exacting specifications to ensure reliable performance in the harsh and demanding conditions typical of industrial environments. Whether your new Avalue device is destined for the laboratory or the factory floor, you can be assured that your product will provide the reliability and ease of operation for which the name Avalue has come to be known.

Your satisfaction is our primary concern. Here is a guide to Avalue's customer services. To ensure you get the full benefit of our services, please follow the instructions below carefully.

Technical Support

We want you to get the maximum performance from your products. So if you run into technical difficulties, we are here to help. For the most frequently asked questions, you can easily find answers in your product documentation. These answers are normally a lot more detailed than the ones we can give over the phone. So please consult the user's manual first.

To receive the latest version of the user's manual; please visit our Web site at:

<http://www.avalue.com.tw/>

Content

1.	Getting Started	7
1.1	Safety Precautions	7
1.2	Packing List.....	7
1.3	System Specifications	8
1.4	System Overview	12
1.4.1	I/O View	12
1.5	System Dimensions	13
2.	Hardware Configuration	14
2.1	ARC-10W33 connector mapping.....	15
2.1.1	Serial port 1 connector (COM1).....	15
2.1.2	Serial port 2 connector (COM2).....	15
2.2	Installing Hard Disk & Memory	16
2.3	Installing ARC-BYT DB	18
2.4	ARC-APL Overviews.....	20
2.5	ARC-APL Jumper and Connector list.....	21
2.6	ARC-APL Jumpers & Connectors settings.....	23
2.6.1	Clear CMOS (JBAT1)	23
2.6.2	Serial port 1/2 pin9 signal select (JRI1/JRI2)	23
2.6.3	PWM Level select (JPWM_SEL1)	24
2.6.4	AT/ATX Input power select (JAT1).....	24
2.6.5	Serial port 1 in RS-232/422/485 mode (JCOM_SEL1).....	25
2.6.6	LCD Inverter connector (JBKL1)	25
2.6.7	On-board header for USB2.0 (JUSB1).....	26
2.6.8	On-board header for USB2.0 (JUSB2).....	26
2.6.9	Battery connector (JBAT1)	27
2.6.10	LCD backlight brightness adjustment (JVR_BTN1)	27
2.6.11	LVDS connector (LVDS1).....	28
2.6.12	AMPLIFIER_R (JSPR1)	29
2.6.13	AMPLIFIER_L (JSPL1).....	29
2.6.14	BIOS SPI connector (BIOS_SPI1).....	30
2.6.15	EC Debug connector (JEC1)	30
2.6.16	B2B connector (JB2B1)	31
2.6.17	Touch panel connector (JTP1)	32
2.6.18	SATA Power connector (SATA_PWR1).....	32

ARC-10W33

2.6.19	FPC connector (JFPC1)	33
2.6.20	Battery connector (JUPS1)	33
2.6.21	Power Button (JBTN1)	34
2.6.22	Miscellaneous setting connector (JFP1)	34
2.6.23	LED Board connector (JLED1)	35
2.6.24	Low pin count connector (JLPC1)	35
2.6.25	Power connector (PWR1)	36
2.7	ARC-BYT DB-A/B/C/D/E/F/G/H/K Overviews	37
2.7.1	ARC-BYT DB-A	37
2.7.2	ARC-BYT DB-B	37
2.7.3	ARC-BYT DB-C	37
2.7.4	ARC-BYT DB-D	38
2.7.5	ARC-BYT DB-E	38
2.7.6	ARC-BYT DB-F	38
2.7.7	ARC-BYT DB-G	39
2.7.8	ARC-BYT DB-H	39
2.7.9	ARC-BYT DB-K	39
2.8	ARC-BYT DB-A/B/C/D/E/F/G/H/K Connector list	40
2.8.1	ARC-BYT DB-A	40
2.8.2	ARC-BYT DB-B	40
2.8.3	ARC-BYT DB-C	40
2.8.4	ARC-BYT DB-D	40
2.8.5	ARC-BYT DB-E	40
2.8.6	ARC-BYT DB-F	41
2.8.7	ARC-BYT DB-G	41
2.8.8	ARC-BYT DB-H	41
2.8.9	ARC-BYT DB-K	41
2.9	ARC-BYT DB-D Connectors settings	43
2.9.1	Serial Port 1 connector (D_COM1)	43
2.9.2	Serial Port 2 connector (D_COM2)	43
2.10	ARC-BYT DB-E Jumpers & Connectors settings	44
2.10.1	CAN2.0 Switch (E_JCAN20)	44
2.10.2	For user update FW (E_JBOOT0)	44
2.10.3	For user update FW (E_JIAP1)	45
2.11	ARC-BYT DB-F Connectors settings	47
2.12	ARC-BYT DB-G Connectors settings	48
2.12.1	Serial Port 1 connector (G_COM1)	48
2.12.2	Serial Port 2 connector (G_COM2)	48
2.12.3	Serial Port 3 connector (G_COM3)	49
2.13	ARC-BYT DB-H Jumpers settings	49

2.13.1	USB Power selector (H_USB_PWR_SEL1).....	49
2.14	ARC-BYT DB-H Connectors settings	50
2.14.1	Serial Port 1 connector (H_COM1).....	50
2.14.2	Serial Port 2 connector (H_COM2).....	50
2.15	ARC-BYT DB-K Connectors settings	51
2.15.1	Serial Port 1 connector (I_COM1)	51
2.15.2	Serial Port 2 connector (I_COM2)	51
3.	BIOS Setup	52
3.1	Introduction	53
3.2	Starting Setup	53
3.3	Using Setup	54
3.4	Getting Help	55
3.5	In Case of Problems.....	55
3.6	BIOS setup.....	56
3.6.1	Main Menu	56
3.6.1.1	System Language.....	57
3.6.1.2	System Date	57
3.6.1.3	System Time.....	57
3.6.2	Advanced Menu.....	57
3.6.2.1	Trusted Computing	58
3.6.2.2	APCI Settings	58
3.6.2.3	IT8528 Super IO Configuration	60
3.6.2.3.1	Serial Port 1 Configuration.....	61
3.6.2.3.2	Serial Port 2 Configuration.....	61
3.6.2.3.3	Serial Port 3 Configuration.....	62
3.6.2.3.4	Serial Port 4 Configuration.....	62
3.6.2.3.5	Serial Port 5 Configuration.....	63
3.6.2.4	H/W Monitor.....	63
3.6.2.5	S5 RTC Wake Settings	64
3.6.2.6	Serial Port Console Redirection	64
3.6.2.6.1	Legacy Console Redirection Settings	65
3.6.2.7	CPU Configuration	65
3.6.2.7.1	Socket 0 CPU Information	66
3.6.2.7.2	CPU Power Management Configuration	66
3.6.2.8	Network Stack Configuration	67
3.6.2.9	CSM Configuration.....	68
3.6.2.10	NVMe Configuration.....	68
3.6.2.11	USB Configuration	69
3.6.2.12	Security Configuration.....	70
3.6.3	Chipset.....	70

ARC-10W33

3.6.3.1	North Bridge	71
3.6.3.2	South Bridge	72
3.6.3.3	Uncore Configuration	72
3.6.3.4	South Cluster Configuration	74
3.6.3.4.1	HD-Audio Configuration	74
3.6.3.4.2	PCI Express Configuration	75
3.6.3.4.2.1	PCI Express Root Port 3	75
3.6.3.4.2.2	PCI Express Root Port 4	76
3.6.3.4.2.3	PCI Express Root Port 5	77
3.6.3.4.2.4	PCI Express Root Port 6	78
3.6.3.4.4	SATA Drives	80
3.6.3.4.3	USB Configuration	81
3.6.4	Security	81
3.6.4.1	Secure Boot menu	82
3.6.5	Boot	83
3.6.6	Save and exit	84
3.6.6.1	Save Changes and Reset	85
3.6.6.2	Discard Changes and Reset	85
3.6.6.3	Restore Defaults	85
3.6.6.4	Launch EFI Shell from filesystem device	85

1. Getting Started

1.1 Safety Precautions

Warning!



Always completely disconnect the power cord from your chassis whenever you work with the hardware. Do not make connections while the power is on. Sensitive electronic components can be damaged by sudden power surges. Only experienced electronics personnel should open the PC chassis.

Caution!



Always ground yourself to remove any static charge before touching the CPU card. Modern electronic devices are very sensitive to static electric charges. As a safety precaution, use a grounding wrist strap at all times. Place all electronic components in a static-dissipative surface or static-shielded bag when they are not in the chassis.

1.2 Packing List

- 1 x ARC-10W33 Panel PC
- 1 x Power Adapter
- 4 x screws for VESA
- 4 x screws for HDD
- 8 x screws for Wall Mount
- 8 x brackets for Wall Mount
- 8 x plastics spacer for Wall Mount



If any of the above items is damaged or missing, contact your retailer.

1.3 System Specifications

Component	
Mother Board	ARC-APL
CPU	Onboard Intel® Celeron® N3350 SoC BGA Processor
CPU Cooler(Type)	Fanless Heatsink
Memory	One 204-pin DDR3L SODIMM Socket, Supports Up to 8GB DDR3L 1600MTs SDRAM (Non-ECC)
Power Supply	DC in
Adapter	60W power adaptor
Speaker	2 W*2
Wireless LAN	Optional USB or MPCle module
Bluetooth	Optional by module
Operating System	Linux, Windows 10
Expansion Card	Compatible to all ARC-BYT DB modules (BIOS auto adjusted) Expandable interface (1 x DP, 1 x PCIe1, 4 x USB, 1 x LPC, 1 x Audio (line in, line out, mic in)) 2 x mini-PCIe Socket
Storage	
Hard Disk Drive	1 x 2.5" Drive Bay
Solid State Drive	1 x 2.5" Drive Bay
Other Storage Device	1 x mSATA supports on the 1st Mini PCIe slot, Auto switch for mSATA or Mini PCIe
Panel	
LCD Panel	10.1", 1280 x 800, TIANMA TM101JDHP03 (E9689410110R)
B/L Inverter/Converter	LCD built in
Touch Screen	ST-101C26E (E968X000190R)
Touch Controller	EETI
External I/O	
Serial Port	1 x DB-9 COM1 (RS-232/422/485, selectable by BIOS & JUPMER, RS-485 supports Auto Flow, Pin-9 selected by Ring/+5V/+12V) 1 x DB-9 COM2 (RS-232, Pin-9 selected by Ring/+5V/+12V)
USB Port	4 x USB3.0 (2 x Double deck)
Video Port	1 x HDMI (by ARC-BYT DB-C)
Audio Port	Realtek ALC892 HD codec
LAN Port	2 x Intel I211AT GbE controller
Wireless LAN Antenna	3 x Antenna
Indicator Light	HDD LED, Power LED (Green for Power, Yellow for HDD)

Expansion Slots	1 x mini PCIe full size (support half size) 1 x mSATA supports on the 1st Mini PCIe slot, Auto switch for mSATA or Mini PCIe
Internal I/O	1 x SATA connector & 1 x 2-pin wafer SATA power connector 1 x 5-pin lockable connector for inverter backlight control with dimming (PWM/DC mode & backlight brightness selected by BIOS as standard) 2 x 3-pin header for LCD backlight brightness adjustment (dimming) 1 x 3-pin header for CMOS (protect*Clear) 1 x 2 x 3-pin header for COM1/ 2 pin 9 signal selection (+5, +12, Ring, selected by jumper) 1 x 2 x 5-pin header for LPC (for test) 1 x 2 x 4-Pin header for SPI 1 x 2 x 5-pin wafer for front panel 1 x 3-pin for Power mode (AT/ATX) 1 x Buzzer 2 x 2-pin wafer for speaker out 1 x 1 x 5-pin 90 degree pin header for touch connector 1 x 1 x 5 pin wafer for 1 USB 2.0 (For USB WiFi) 1 x 8 pin FPC for SM bus 1 x 2 x 40-pin board to board connector for Expansion board (Hirose FX18-80P-0.8SH & FX18-80S-0.8SH)
Mechanical	
Power Type	AT/ATX
Power Requirement	DC +9V ~ +36V, wide voltage single power input TVS component for surge protection Reverse current/voltage protection
ACPI	Single power ATX Support S0, S3, S4, S5 and ACPI 3.0 Compliant
Power Connector Type	2.5mm Lockable DC Jack
Dimension	282.29 x 200.93 x 50.9mm
Weight	2.3 Kgs
Color	Front: Die-Casting with Cover lens; Rear: Black Casting-Aluminum
Fanless	Yes
OS Support	Linux, Windows 10
Reliability	
EMI Test	CE/ FCC class B
Dust and Rain Test	Front Panel IP65, Rear IP41 except I/O
Vibration Test	Random Vibration Operation: 1. PSD: 0.00454G ² /Hz , 1.5 Grms 2. operation mode

	<p>3. Test Frequency : 5-500Hz</p> <p>4. Test Axis : X,Y and Z axis</p> <p>5. 30 minutes per each axis</p> <p>6. IEC 60068-2-64 Test:Fh</p> <p>7. Storage : CF or SSD</p> <p>Sine Vibration test (Non-operation)</p> <p>1 Test Acceleration : 2G</p> <p>2 Test frequency : 5~500 Hz</p> <p>3 Sweep : 1 Oct/ per one minute. (logarithmic)</p> <p>4 Test Axis : X,Y and Z axis</p> <p>5 Test time :30 min. each axis</p> <p>6 System condition : Non-Operating mode</p> <p>7. Reference IEC 60068-2-6 Testing procedures</p> <p>Package vibration test</p> <p>1. PSD: 0.026G²/Hz , 2.16 Grms</p> <p>2. Non-operation mode</p> <p>3. Test Frequency : 5-500Hz</p> <p>4. Test Axis : X,Y and Z axis</p> <p>5. 30 min. per each axis</p> <p>6. IEC 60068-2-64 Test:Fh</p>
Mechanical Shock Test	<p>1. Wave form : Half Sine wave</p> <p>2. Acceleration Rate : 20g for operation mode</p> <p>3. Duration Time : 11ms</p> <p>4. No. of Shock : +/- X,Y,Z axis 3 times</p> <p>5. Test Axis: +/- X,Y,Z axis</p> <p>6. Operation mode</p> <p>7. Reference IEC 60068-2-27 Testing procedures Test Eb : Shock Test</p>
Drop Test	<p>Package drop test</p> <p>1 One corner , three edges, six faces</p> <p>2 ISTA 2A, IEC-60068-2-32 Test:Ed</p>
Operating Temperature	-10 ~ +50 degree C
Operating Humidity	0 ~ 90% Relative Humidity, Non-condensing
Storage Temperature	-20 ~ 60 degree
Compliant with following Flexible Expansion Modules	
ARC-BYT DB-A	4 x USB3.0 module

ARC-BYT DB-B	3 x Audio Jack (Line in/Line out/Mic in)+HDMI
ARC-BYT DB-C	HDMI + Mini PCIe (w/ SIM slot)
ARC-BYT DB-D	2 x COM Isolation module
ARC-BYT DB-G	3 x COM (w/o isolation, RS-232 only)
ARC-BYT DB-H	2COM (RS-232) + 1USB 2.0
ARC-BYT DB-K	2COM (RS-232) + 1LAN
ARC-BYT DB-E	12-bit GPIO+CAN Bus
ARC-BYT DB-F	CAN Bus for OBDII



Note: Specifications are subject to change without notice.

1.4 System Overview

1.4.1 I/O View

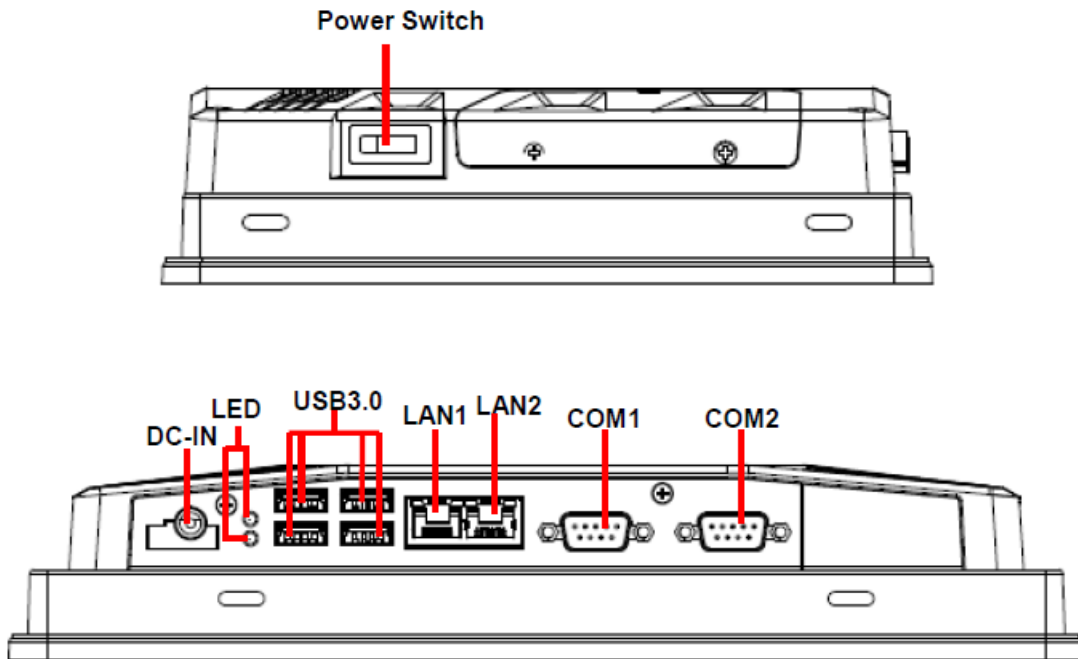

Connectors

Label	Function	Note
DC-IN	DC Power-in connector	Default: Lockable DC Jack Optional: Phoenix Connector(MOQ apply)
COM1/2	Serial port 1/2 connector	DB-9 male connector
USB	4 x USB 3.0 connector	
LAN1/2	RJ-45 Ethernet 1/2	
LED	HDD/Power LED indicator	
Power Switch	Power on button	

1.5 System Dimensions

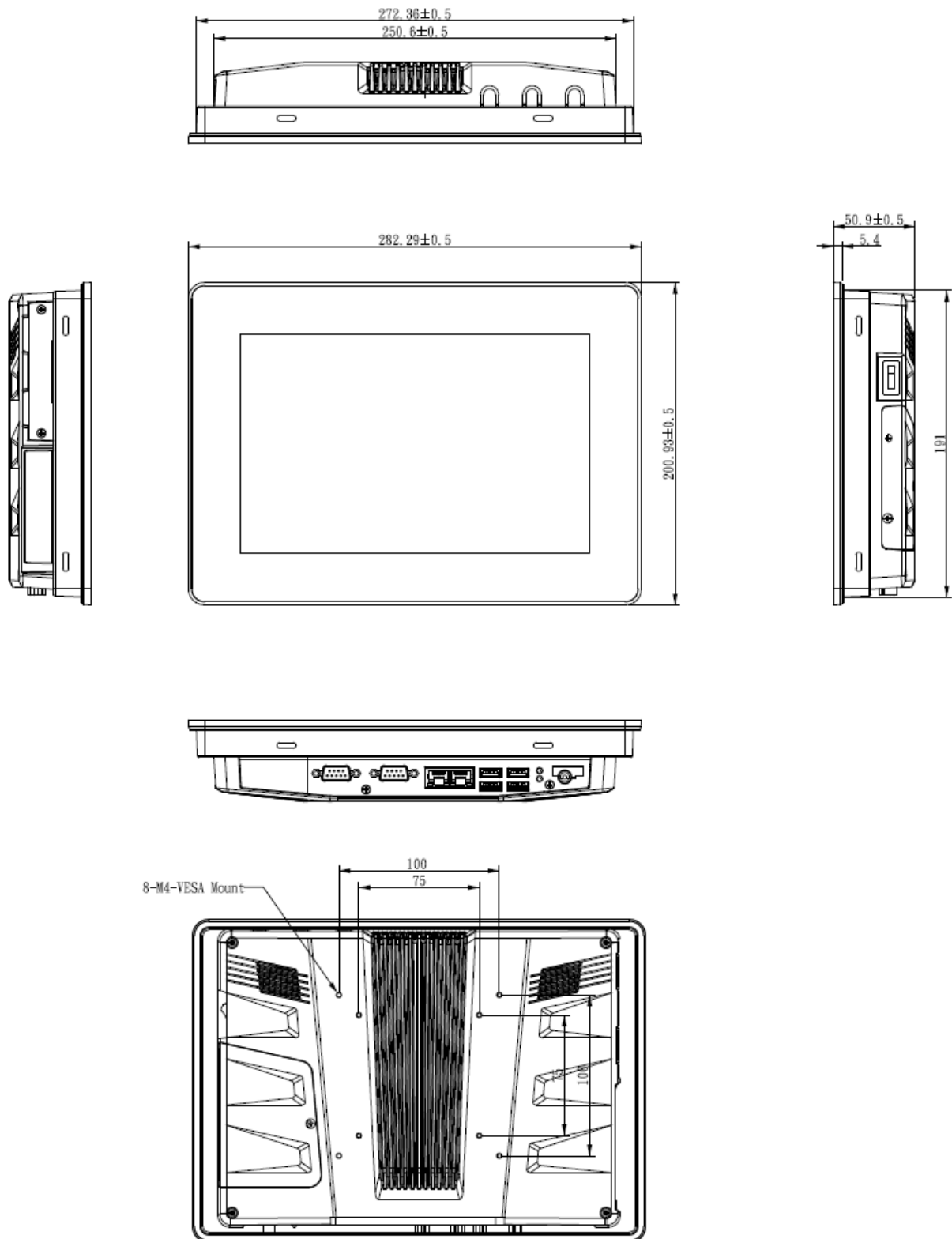

(Unit: mm)

2. Hardware Configuration

For advanced information, please refer to:

- 1- ARC-APL, ARC-BYT DB-A/B/C/D/E/F/G/H/K included in this manual.



Note: If you need more information, please visit our website:

<http://www.avalue.com.tw>

2.1 ARC-10W33 connector mapping

2.1.1 Serial port 1 connector (COM1)

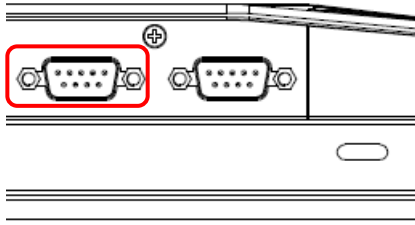

RS-485

Signal	PIN	PIN	Signal
DATA-	1	6	NC
DATA+	2	7	NC
NC	3	8	NC
NC	4	9	NC
GND	5		

Please set BIOS & JCOM1_SEL1

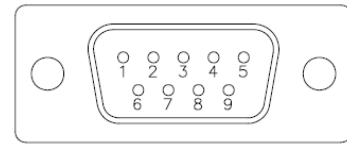

RS-232

Signal	PIN	PIN	Signal
NDCDA#	1	6	NDSRA#
NRXDA	2	7	NRTSA#
NTXDA	3	8	NCTSA#
NDTRA#	4	9	NRIA#
GND	5		

RS-422

Signal	PIN	PIN	Signal
TxD-	1	6	NC
TxD+	2	7	NC
RxD+	3	8	NC
RxD-	4	9	NC
GND	5		

Please set BIOS & JCOM1_SEL1

2.1.2 Serial port 2 connector (COM2)

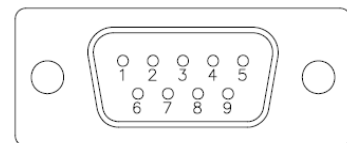
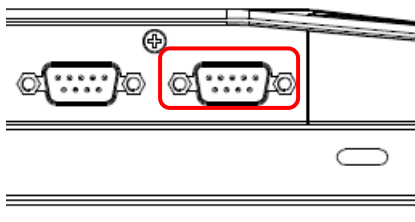

Signal	PIN	PIN	Signal
NDCDB#	1	6	NDSRB#
NRXDB	2	7	NRTSB#
NTXDB	3	8	NCTSB#
NDTRB#	4	9	NRIB#
GND	5		

2.2 Installing Hard Disk & Memory

Step 1. Memory Installation: Remove 3 screws to release the chassis cover, and remove it.

Step 2.1 Insert the SODIMM into the memory socket.

Step 2.2 Re-assemble your system back through previous steps to complete the installation.

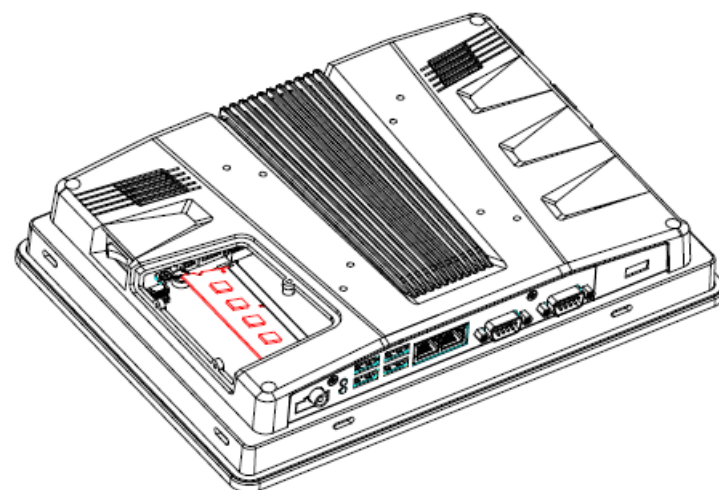
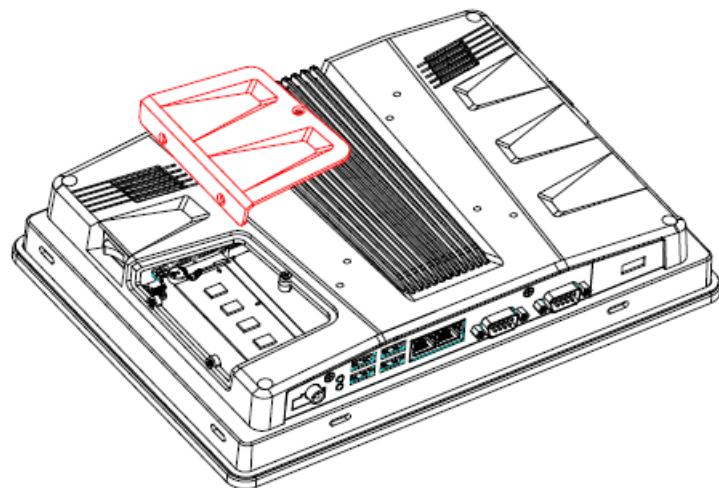
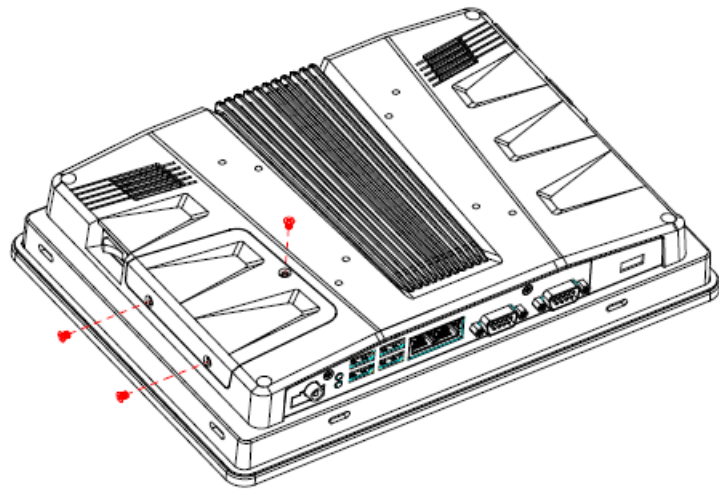

Step 3. HDD Installation: Insert the HDD into the Drive Bay and fasten 2 screws.

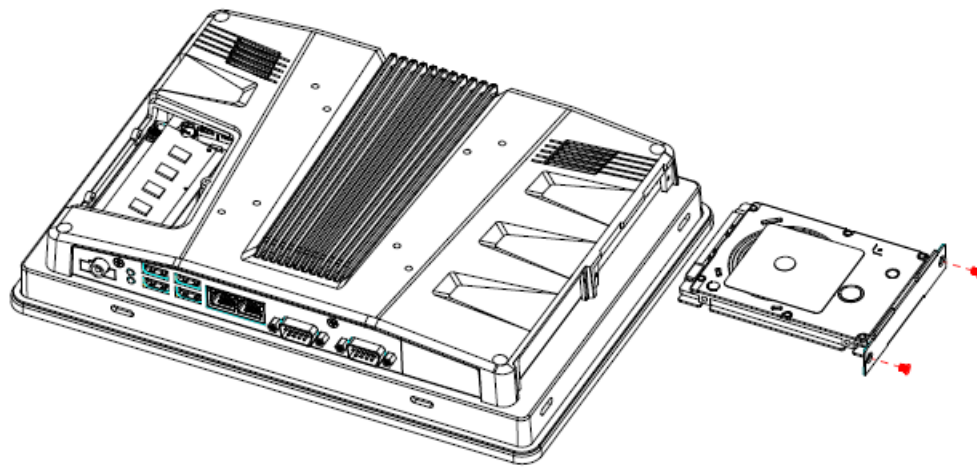

2.3 Installing ARC-BYT DB

Step 1. Unfasten 2 screws of the HDD bracket and take it off.

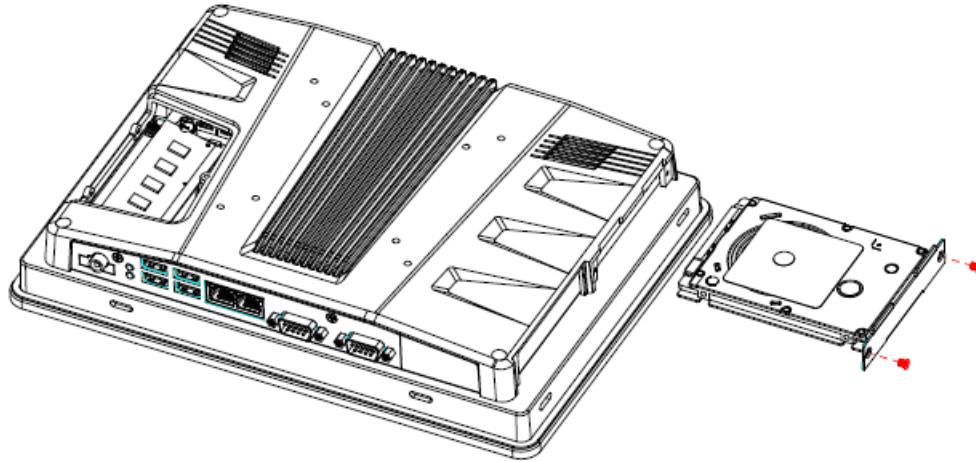

Step 2. Remove 4 screws to release the chassis cover, and remove it.

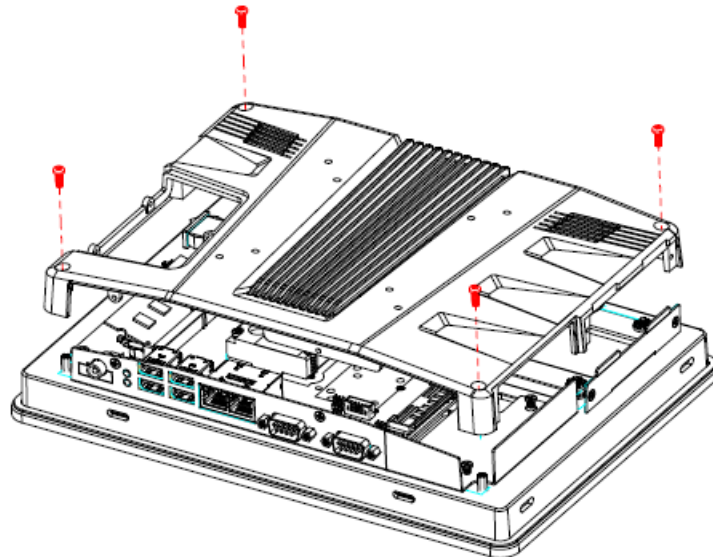

Step 2.1 Insert the ARC-BYT DB into the socket and fasten 3 screws.

Step 2.2 Re-assemble your system back through previous steps to complete the installation

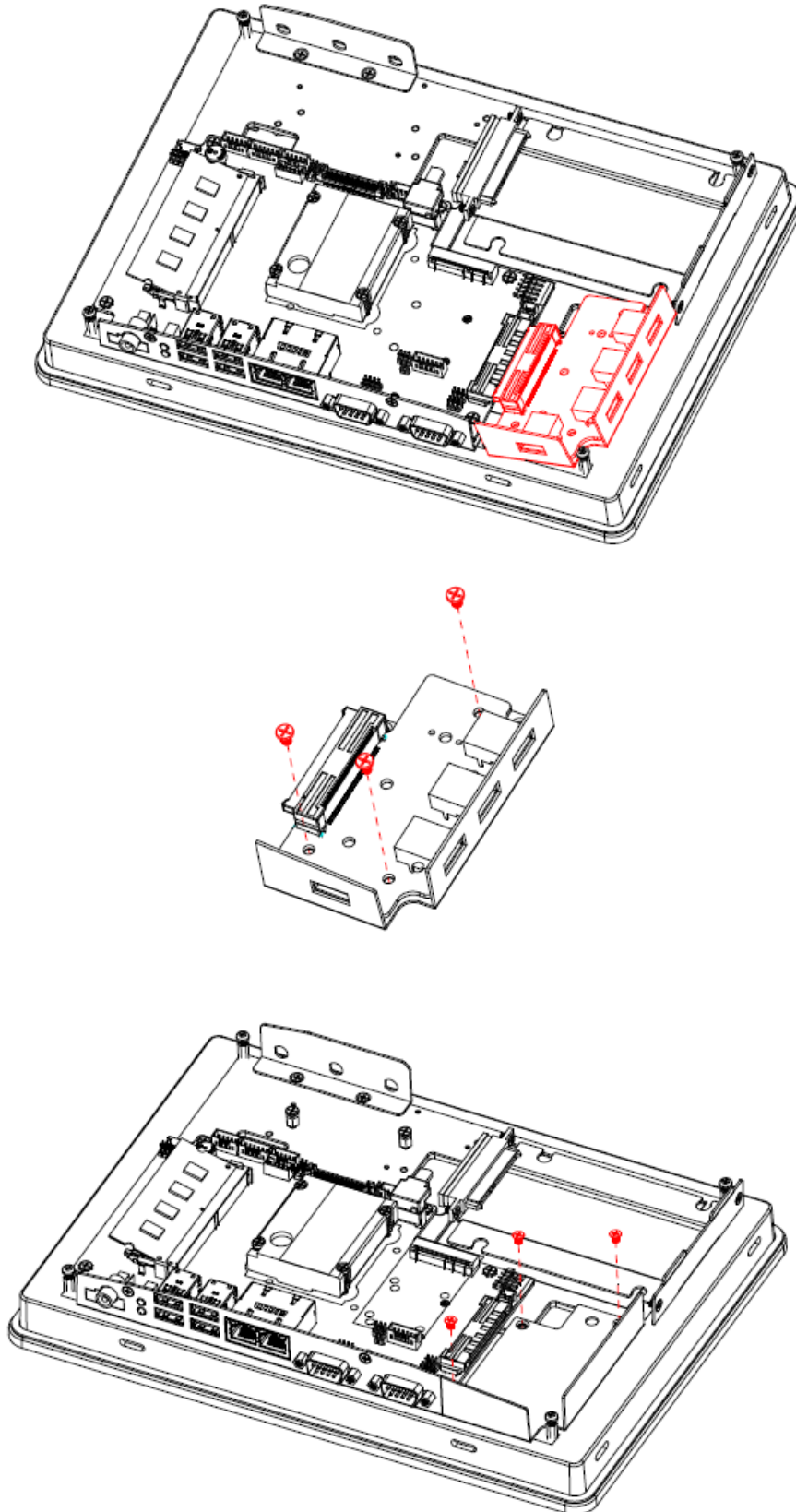

2.5 ARC-APL Jumper and Connector list

Jumper

Label	Function	Note
JBAT1	Clear CMOS	3 x 1 header, pitch 2.00mm
JRI1/2	Serial port 1/2 pin9 signal select	3 x 2 header, pitch 2.00mm
JCOM_SEL1	Serial port 1 in RS-232/422/485 mode	4 x 3 header, pitch 2.00mm
JPWM_SEL1	PWM Level select	3 x 1 header, pitch 2.00mm
JAT1	AT/ATX Input power select	3 x 1 header, pitch 2.00mm

Connectors

Label	Function	Note
SO_DIMM1	1 x 204-Pin DDR3L 1866MHz SO-DIMM	
JFP1	Miscellaneous setting connector	5 x 2 wafer, pitch 2.00 mm
JLPC1	Low pin count connector	5 x 2 header, pitch 2.00 mm
JBKL1	LCD Inverter connector	5 x 1 wafer, pitch 2.00mm Matching Connector: JST PHR-5
COM1/2	Serial Port 1/2 connector	D-sub 9 pin, male
JTP1	Touch panel connector	5 x 1 header, pitch 2.54mm
JSPR1	AMPLIFIER_R	2 x 1 wafer, pitch 2.00mm
JSPL1	AMPLIFIER_L	2 x 1 wafer, pitch 2.00mm
JB2B1	B2B connector	40 x 2 wafer, pitch 0.80mm
JVR_BTN1	LCD backlight brightness adjustment	3 x 2 header, pitch 2.00mm
LED1	HDD/Power LED indicator	
JLED1	LED Board connector	3 x 1 header, pitch 2.00mm
LVDS1	LVDS connector	DIN 40-pin wafer, pitch 1.25mm Matching Connector: Hirose DF13-40DS-1.25C
USB1/2	USB connector 1/2	
JUSB1	On-board header for USB2.0	5 x 1 wafer, pitch 2.00mm
JUSB2	On-board header for USB2.0	5 x 1 wafer, pitch 2.00mm
ULAN1/2	RJ-45 Ethernet 1/2	
MPCIE1	Mini-PCle connector	
BT1	Battery connector	2 x 1 wafer, pitch 1.25mm
PWR1	Power connector	

ARC-10W33

BIOS_SPI1	BIOS SPI header	4 x 2 header, pitch 2.00 mm
JEC1	EC Debug connector	2 x 1 header, pitch 2.00 mm
SATA1	Serial ATA connector	
SATA_PWR1	SATA Power connector	2 x 1 wafer, pitch 2.00mm
JFPC1	FPC connector	8 x 1 wafer, pitch 0.50mm
JUPS1	Battery connector	2 x 2 header, pitch 2.00mm
JBTN1	Power Button	2 x 1 wafer, pitch 2.00mm

2.6 ARC-APL Jumpers & Connectors settings

2.6.1 Clear CMOS (JBAT1)

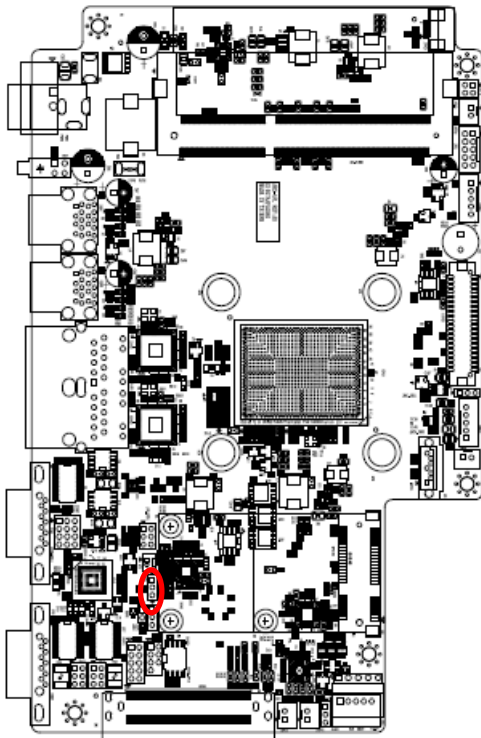

Protect*

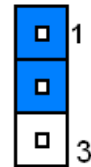

Clear CMOS

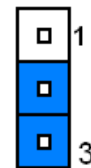

*Default

2.6.2 Serial port 1/2 pin9 signal select (JRI1/JRI2)

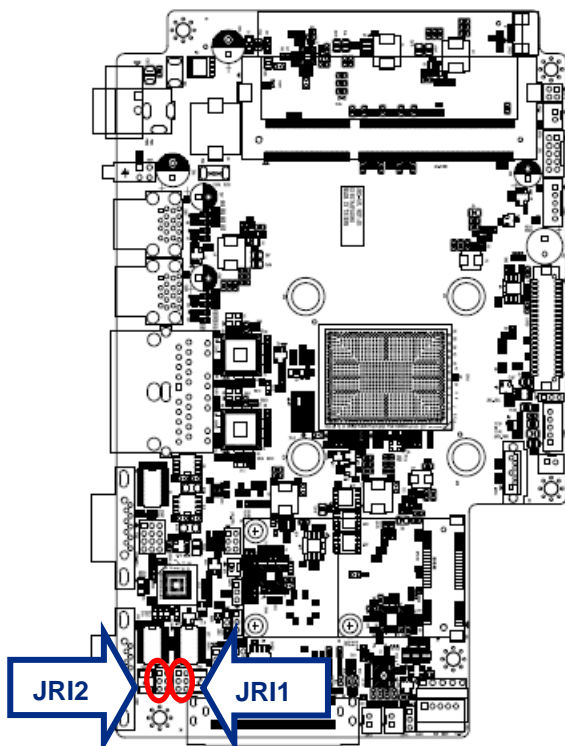

Ring*

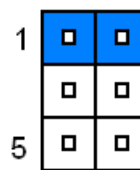

+5V

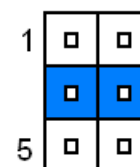

+12V

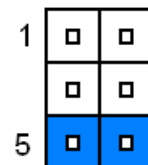

* Default

ARC-10W33

2.6.3 PWM Level select (JPWM_SEL1)

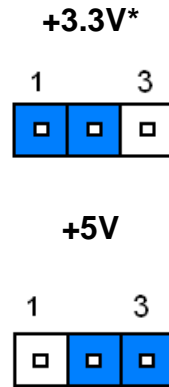
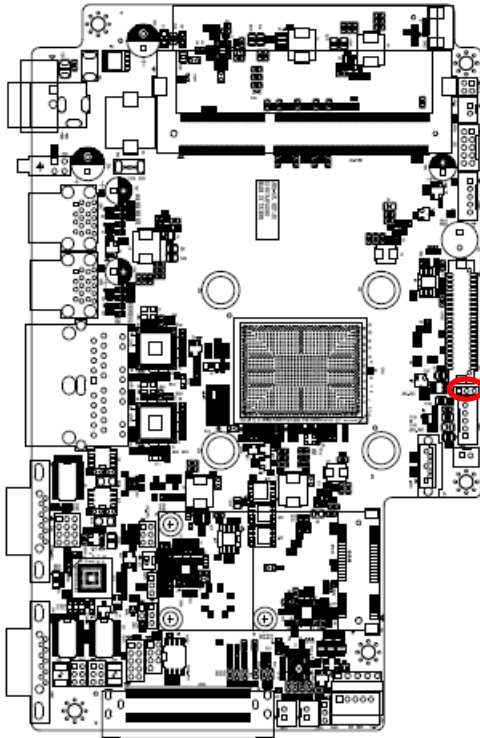

* Default

2.6.4 AT/ATX Input power select (JAT1)

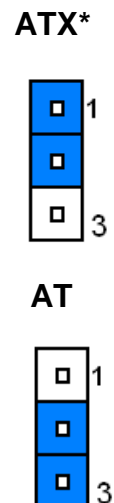
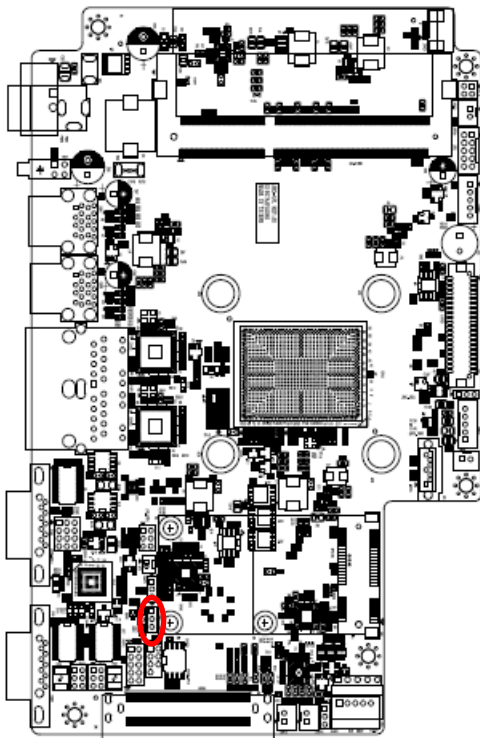

* Default

2.6.5 Serial port 1 in RS-232/422/485 mode (JCOM_SEL1)

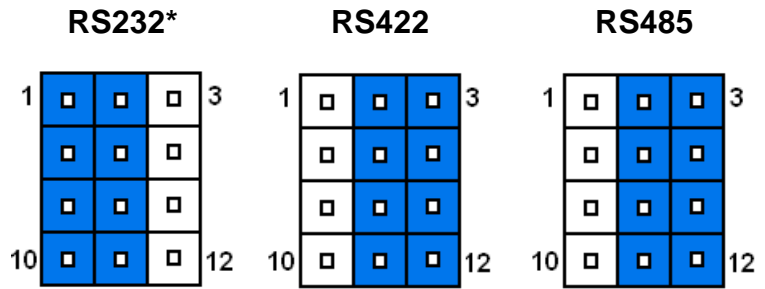
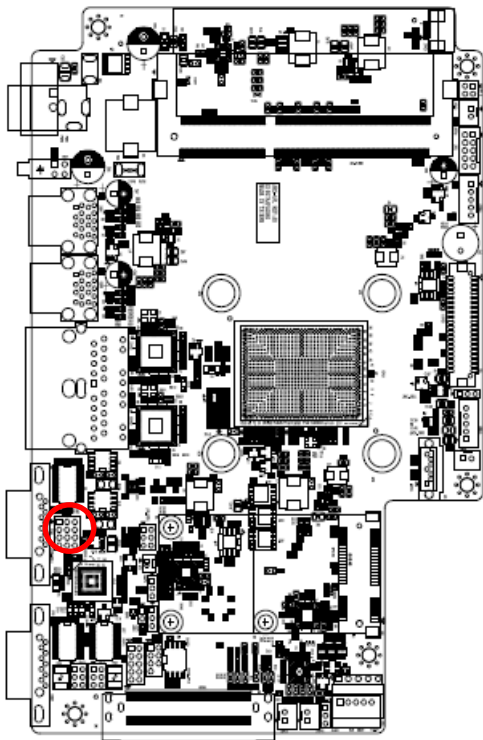

PIN	Signal	PIN	Signal	PIN	Signal
1	NDCDA#	2	COM1-1	3	485_422TX1-
4	NTXDA	5	COM1-3	6	422RX1+
7	NRXDA	8	COM1-2	9	485_422TX1+
10	NDTRA#	11	COM1-4	12	422RX1-

Note:

This connector is available after modify the mode of COM1 in BIOS setting.

* Default

2.6.6 LCD Inverter connector (JBKL1)

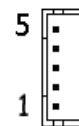
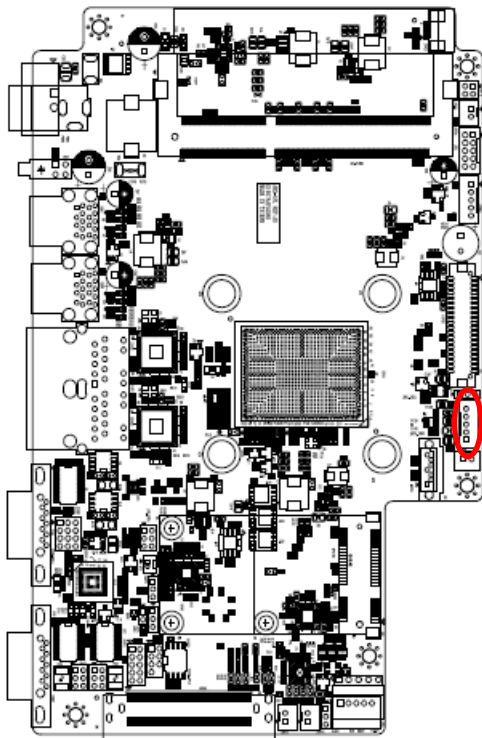

Signal	PIN
+5V	5
VBRIGHT	4
BKLEN	3
GND	2
+12V	1

2.6.7 On-board header for USB2.0 (JUSB1)

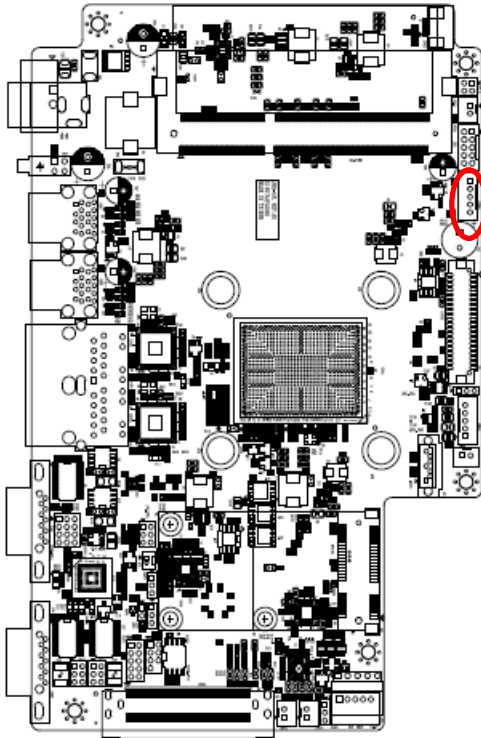

Signal	PIN
+5VSB	1
USB_R_DN6	2
USB_R_DP6	3
GND	4
GND	5

2.6.8 On-board header for USB2.0 (JUSB2)

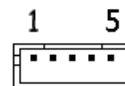
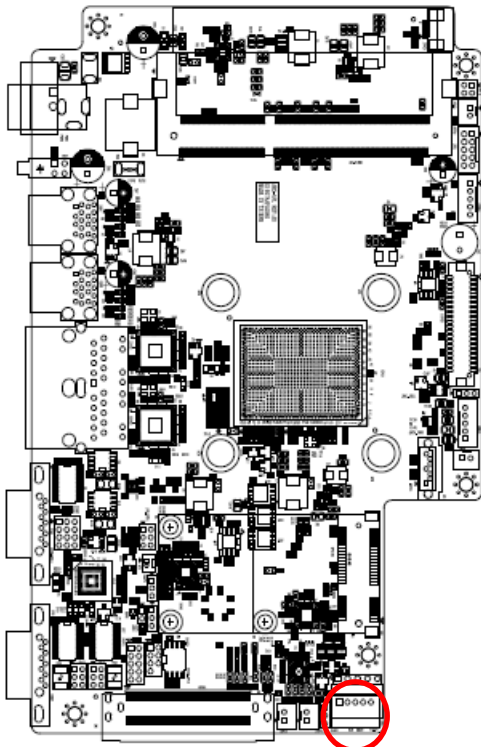

Signal	PIN
+5VSB	1
USB_CA_PN7	2
USB_CA_PP7	3
GND	4
GND	5

2.6.9 Battery connector (JBAT1)

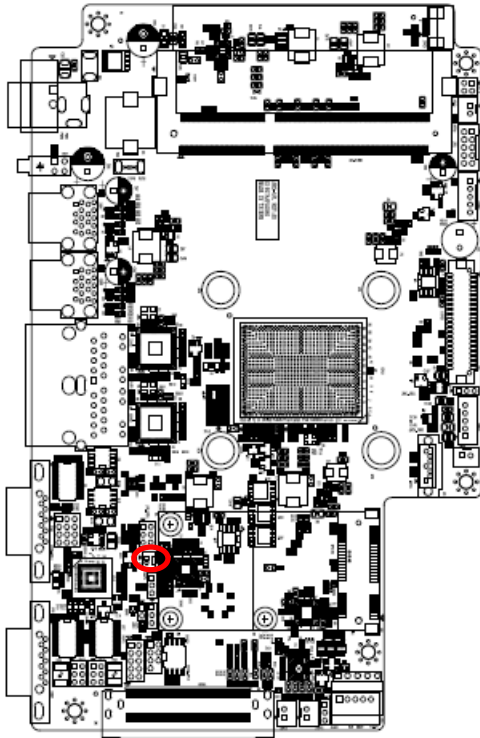

Signal	PIN
+RTCBATT	1
GND	2

2.6.10 LCD backlight brightness adjustment (JVR_BTN1)

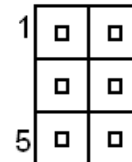
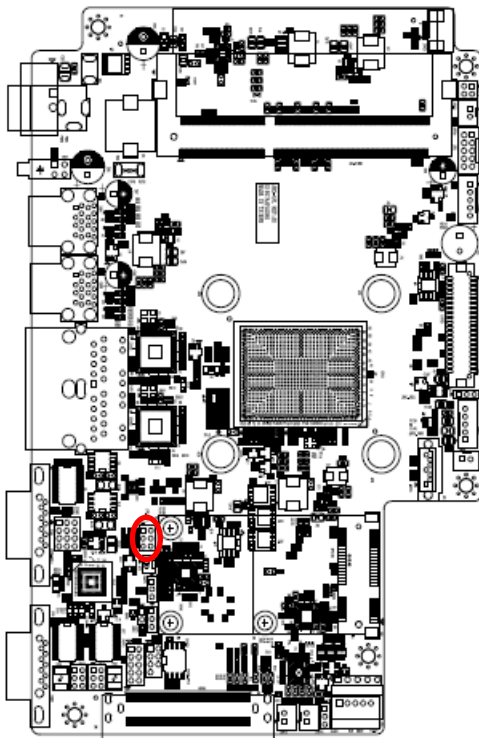

PIN	Signal	Note
1-2	BLK_VR_MOD	VR must select 10K/1%
3-4	BLK_BRI_UP	Low pulse button for backlight brighter
5-6	BLK_BRI_DN	Low pulse button for backlight dim

2.6.11 LVDS connector (LVDS1)

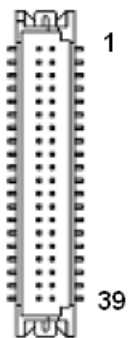
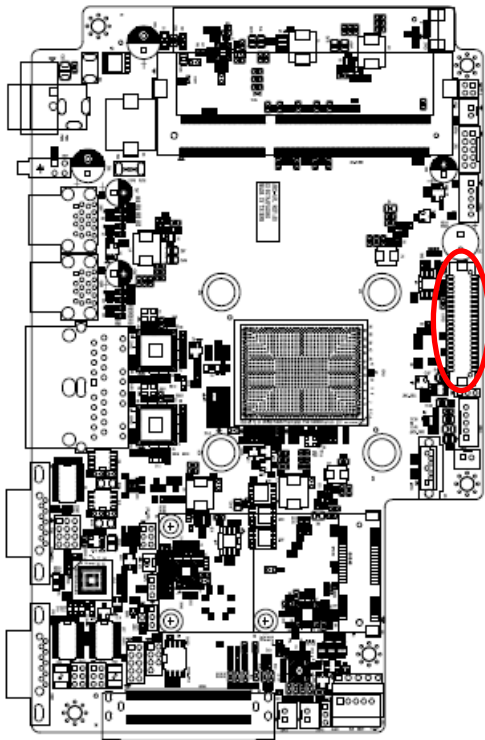

Signal	PIN	PIN	Signal
+5V	2	1	+3.3V
+5V	4	3	+3.3V
NC	6	5	NC
GND	8	7	GND
LVDS_DATA0_P	10	9	LVDS_DATA1_P
LVDS_DATA0_N	12	11	LVDS_DATA1_N
GND	14	13	GND
LVDS_DATA2_P	16	15	LVDS_DATA3_P
LVDS_DATA2_N	18	17	LVDS_DATA3_N
GND	20	19	GND
LVDS_DATA4_P	22	21	LVDS_DATA5_P
LVDS_DATA4_N	24	23	LVDS_DATA5_N
GND	26	25	GND
LVDS_DATA6_P	28	27	LVDS_DATA7_P
LVDS_DATA6_N	30	29	LVDS_DATA7_N
GND	32	31	GND
LVDS_CLK1_P	34	33	LVDS_CLK2_P
LVDS_CLK1_N	36	35	LVDS_CLK2_N
GND	38	37	GND
+12V	40	39	+12V

2.6.12 AMPLIFIER_R (JSPR1)

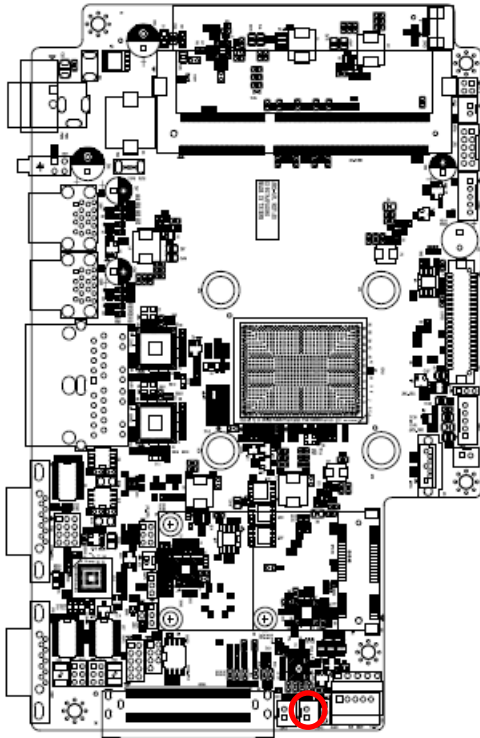

Signal	PIN
SPK_R-	2
SPK_R+	1

2.6.13 AMPLIFIER_L (JSPL1)

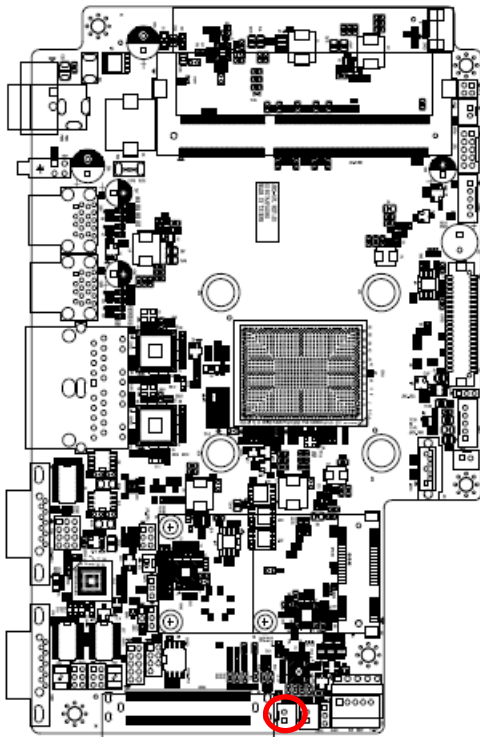

Signal	PIN
SPK_L-	2
SPK_L+	1

2.6.14 BIOS SPI connector (BIOS_SPI1)

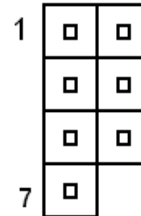
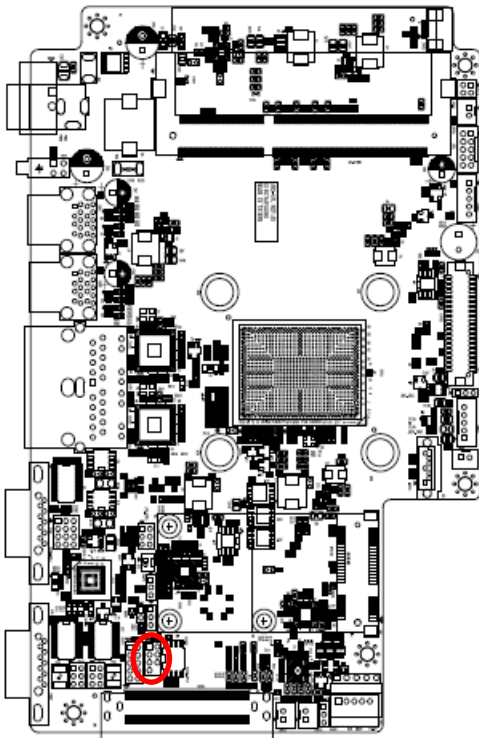

Signal	PIN	PIN	Signal
+1.8VSB	1	2	GND
SPI_CS#0	3	4	SPI_CLK
SPI_MISO	5	6	SPI_MOSI
SPI_HOLD#	7		

2.6.15 EC Debug connector (JEC1)

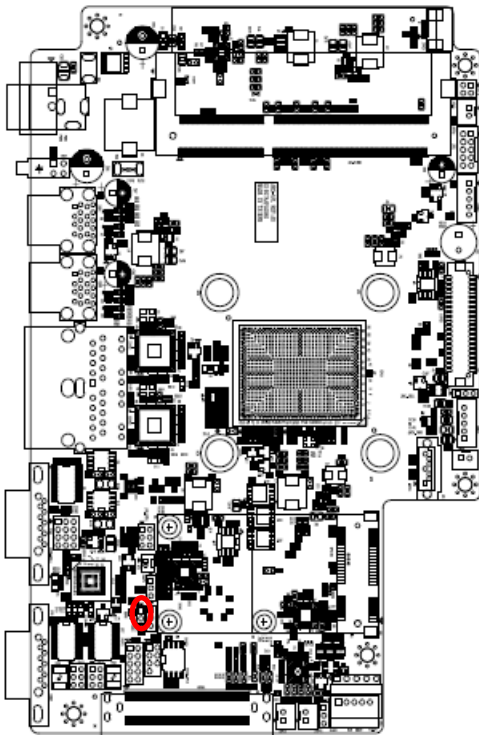

Signal	PIN
EC_SMCLK_DEBUG	1
EC_SMDAT_DEBUG	2

2.6.16 B2B connector (JB2B1)

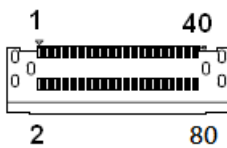
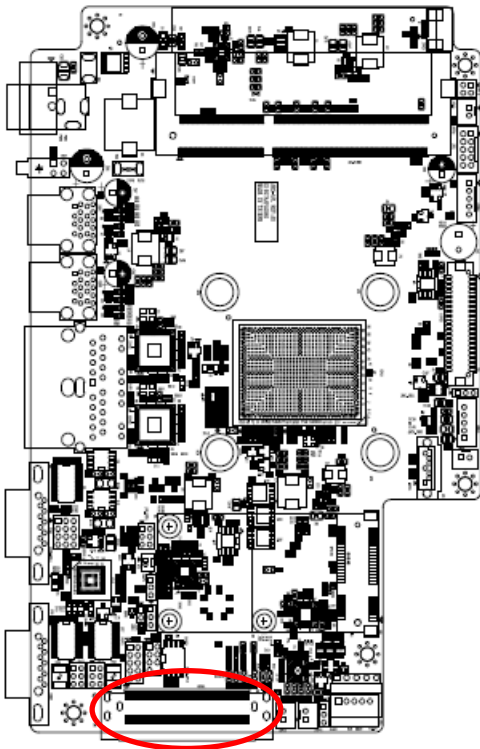

Signal	PIN	PIN	Signal
GND	1	41	GND
GND	2	42	GND
+12V	3	43	GND
+12V	4	44	GND
GND	5	45	GND
LPC_SERIRQ	6	46	+5VSB
LPC_FRAME#	7	47	+5VSB
LPC_IET_CLK1	8	48	+5VSB
LPC_AD0	9	49	+5VSB
LPC_AD1	10	50	+5VSB

Signal	PIN	PIN	Signal
LPC_AD2	11	51	GND
LPC_AD3	12	52	USB_DP_4
PS_ON_B2B	13	53	USB_DN_4
PLT_RST_BUF#	14	54	GND
PCH_SLP_S3#	15	55	SMB_SCL_S5
HDMI_HPD_CONN	16	56	SMB_SDA_S5
GND	17	57	GND
HDMI_DDC_CLK	18	58	NC
HDMI_DDC_DAT	19	59	PCIEUSB3_PONRSTB
GND	20	60	PCIEUSB3_SMIB_INT#
HDMI_TX_N2	21	61	PCIE_WAKE#_3
HDMI_TX_P2	22	62	PLT_RST_BUF#
GND	23	63	PCIE_CLKREQ#_3
HDMI_TX_N1	24	64	GND
HDMI_TX_P1	25	65	PCIE_TXN_3
GND	26	66	PCIE_TXP_3
HDMI_TX_N0	27	67	GND
HDMI_TX_P0	28	68	PCIE_RXN_3
GND	29	69	PCIE_RXP_3
HDMI_CLKN	30	70	GND
HDMI_CLKP	31	71	CLK_PCIE_N3
GND	32	72	CLK_PCIE_P3
GND	33	73	GND
MIC1-R-IN	34	74	GND
MIC1-L-IN	35	75	MIC1_JD
GND	36	76	GND
FRONT-JD	37	77	LINE1-JD
FRONT-R-OUT	38	78	LINE1-R-IN
FRONT-L-OUT	39	79	LNE1-L-IN
GND	40	80	GND

2.6.17 Touch panel connector (JTP1)

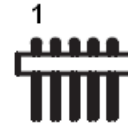
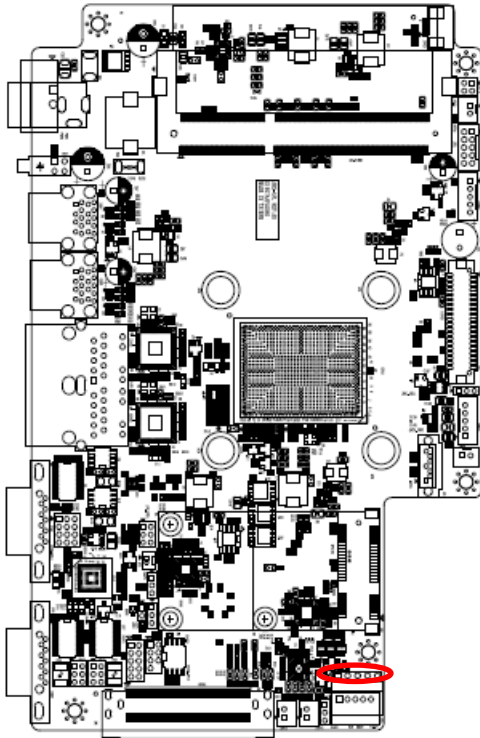

Signal	PIN
X+	1
X-	2
SENSE	3
Y+	4
Y-	5

2.6.18 SATA Power connector (SATA_PWR1)

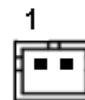
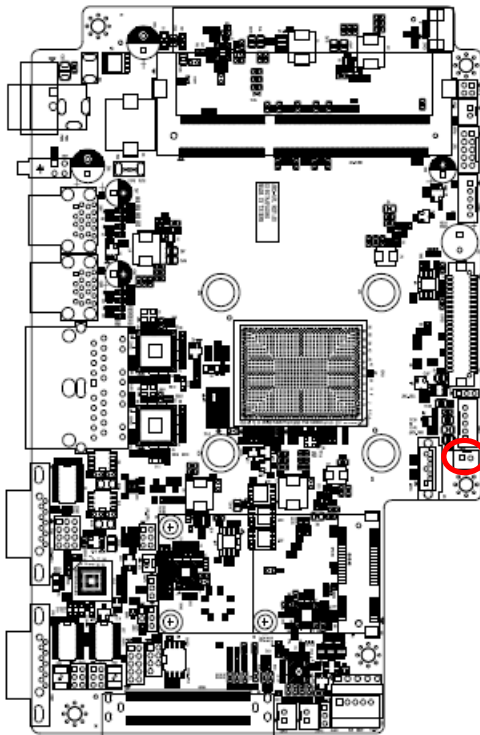

Signal	PIN
GND	1
+5V	2

2.6.19 FPC connector (JFPC1)

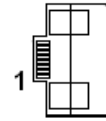
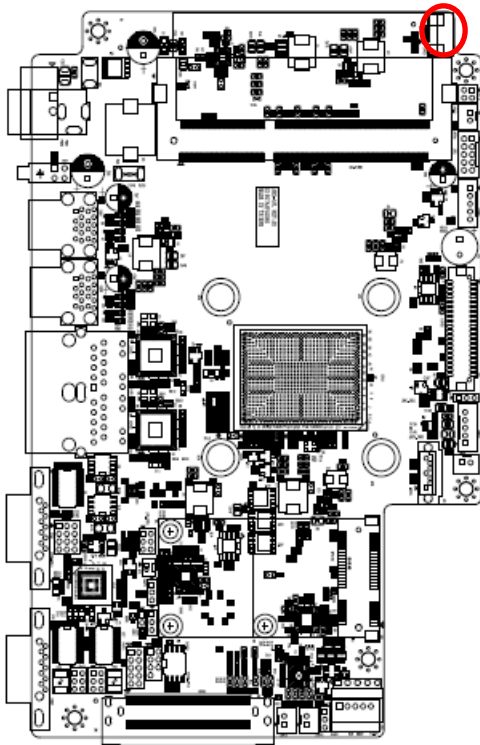

Signal	PIN
+5VSB	8
+3.3VSB	7
EC_SMDAT	6
NC	5
EC_SMCLK	4
AUX_INT1#	3
+5VSB	2
GND	1

2.6.20 Battery connector (JUPS1)

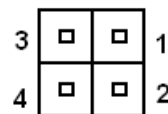
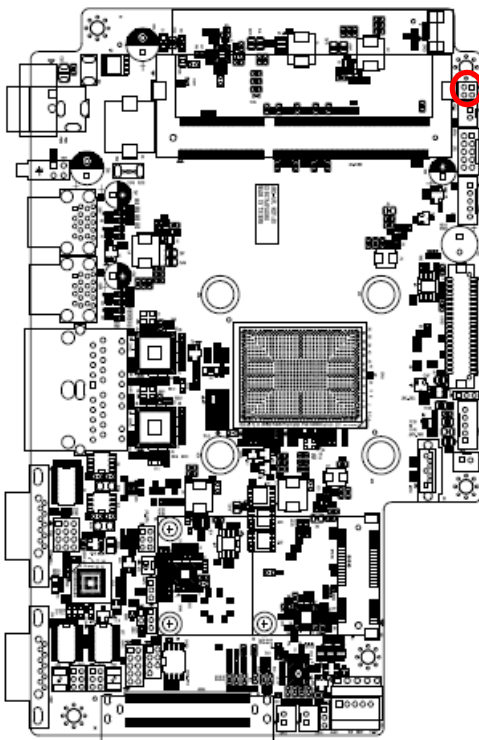

Signal	PIN	PIN	Signal
AC_PRESENT2	3	1	AC_PRESENT1
SMB_DSA_S0	4	2	SMB_SCL_S0

ARC-10W33

2.6.21 Power Button (JBTN1)

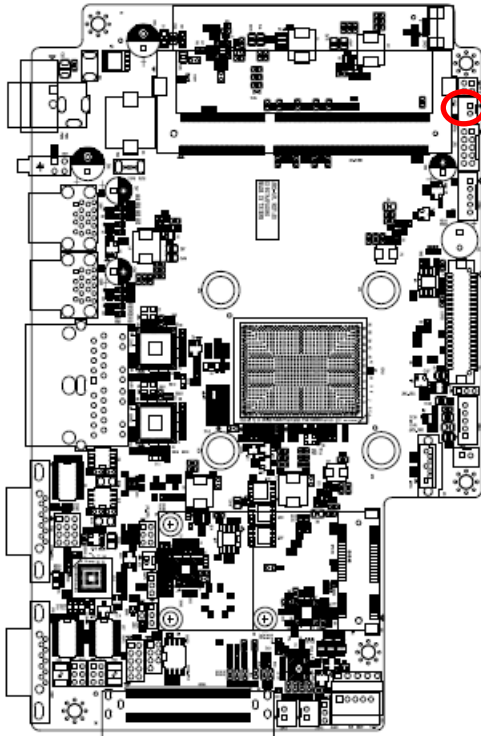

Signal	PIN
BUTTON	1
GND	2

2.6.22 Miscellaneous setting connector (JFP1)

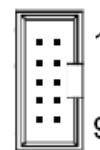
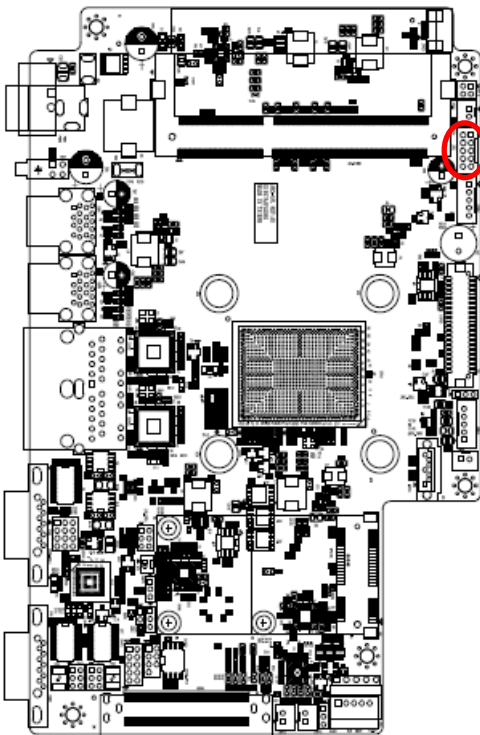

Signal	PIN	PIN	Signal
+3.3VSB	2	1	GND
VOL_UP#	4	3	VOL_DN#
BRI_UP#	6	5	BRI_DN#
LED_ONOFF#	8	7	PWR_BTN_IN_EC#
POWER_LED2	10	9	POWER_LED1

2.6.23 LED Board connector (JLED1)

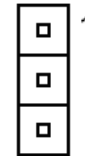
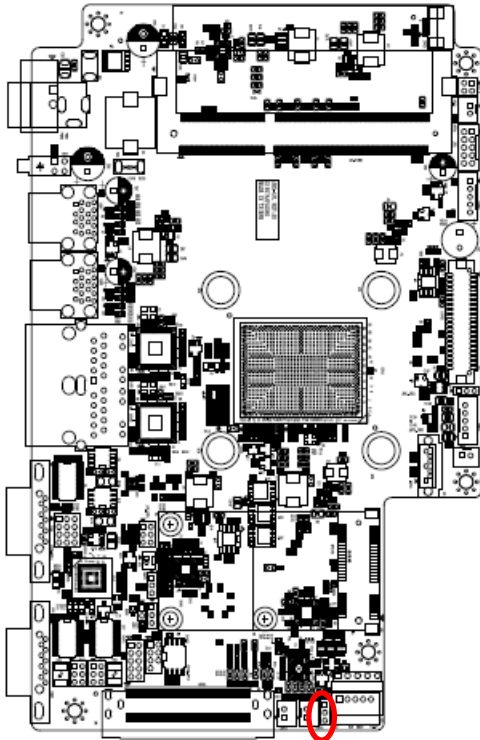

Signal	PIN
+5VSB	1
LUMEN_EN	2
GND	3

2.6.24 Low pin count connector (JLPC1)

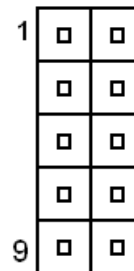
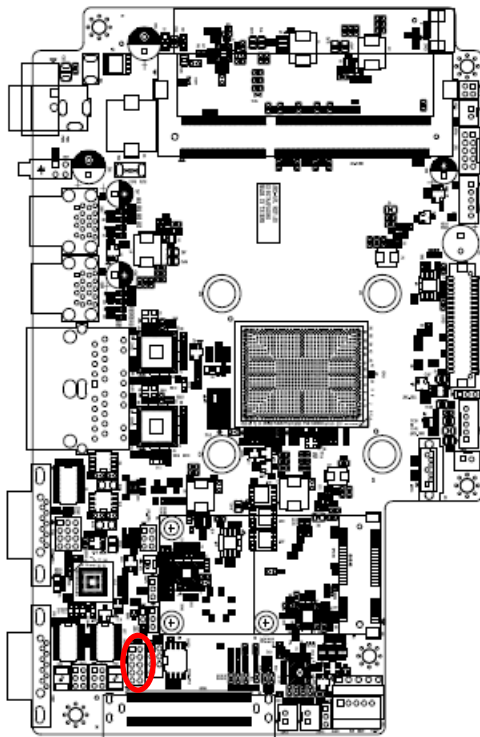

Signal	PIN	PIN	Signal
LPC_AD0	1	2	+3.3V
LPC_AD1	3	4	PLT_RST_BUF#
LPC_AD2	5	6	LPC_FRAME#
LPC_AD3	7	8	LPC_PORT80_CLK
LPC_SERIRQ	9	10	GND

ARC-10W33

2.6.25 Power connector (PWR1)

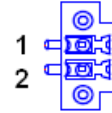
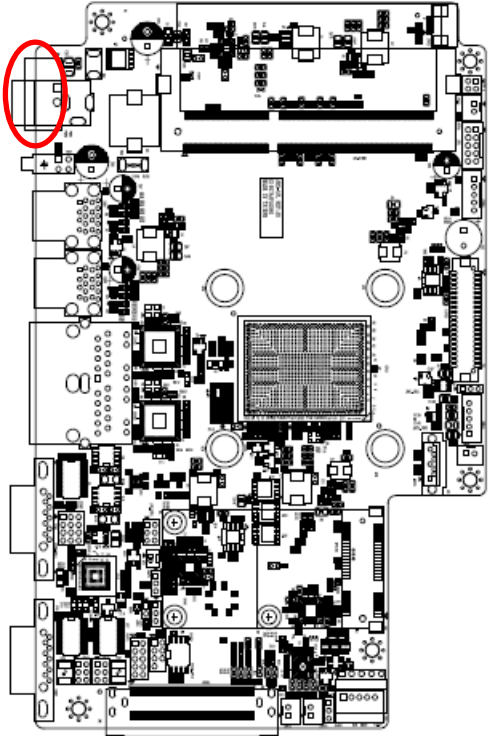

***Optional: Phoenix Connector**

Signal	PIN
+DCIN	1
GND	2

2.7 ARC-BYT DB-A/B/C/D/E/F/G/H/K Overviews

2.7.1 ARC-BYT DB-A

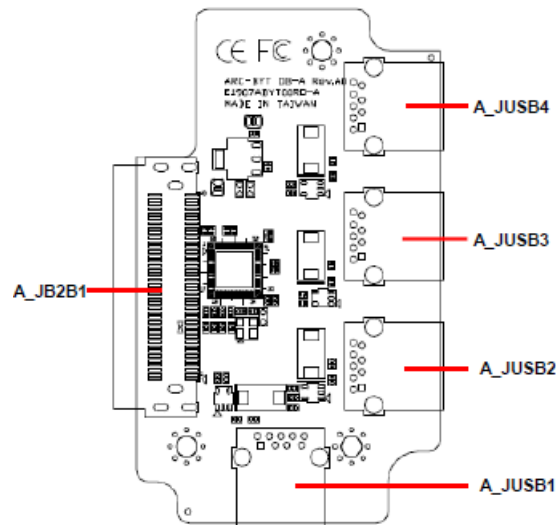

2.7.2 ARC-BYT DB-B

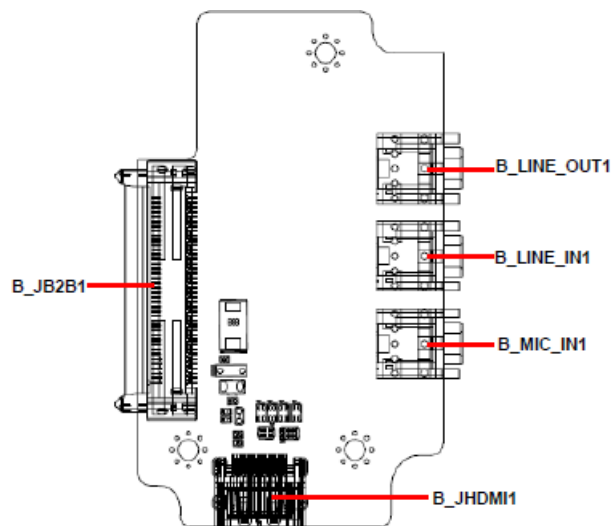

2.7.3 ARC-BYT DB-C

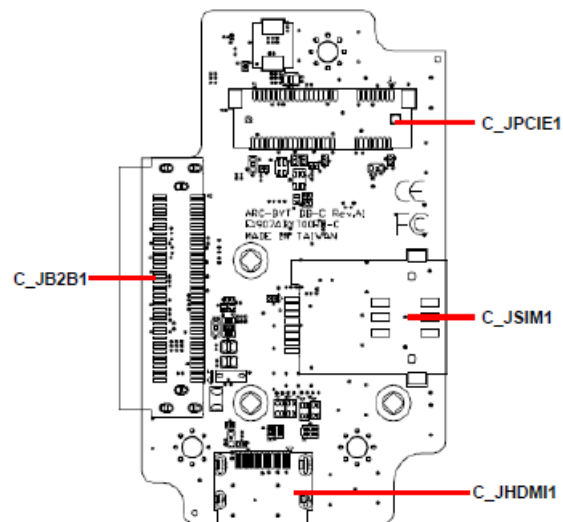

ARC-10W33

2.7.4 ARC-BYT DB-D

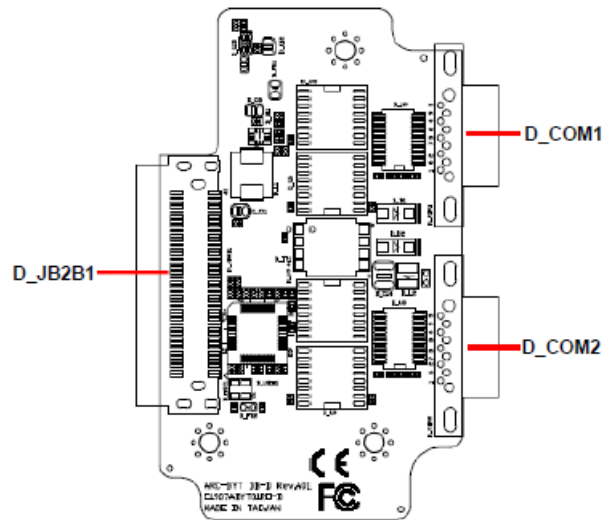

2.7.5 ARC-BYT DB-E

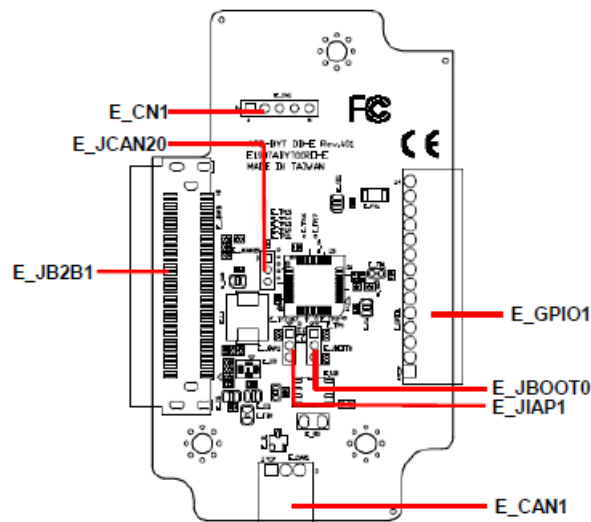

2.7.6 ARC-BYT DB-F

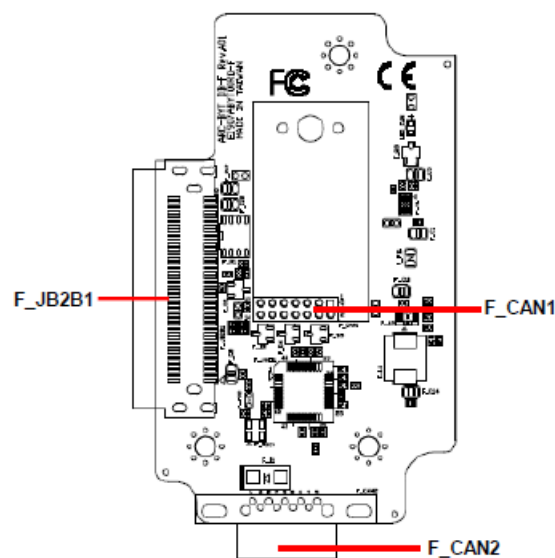

2.7.7 ARC-BYT DB-G

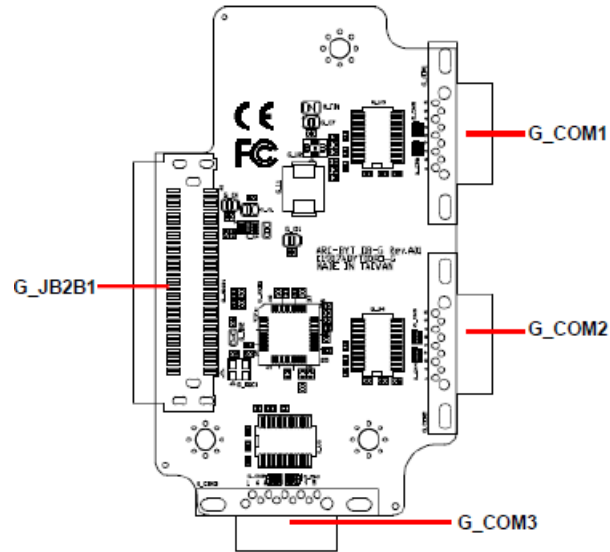

2.7.8 ARC-BYT DB-H

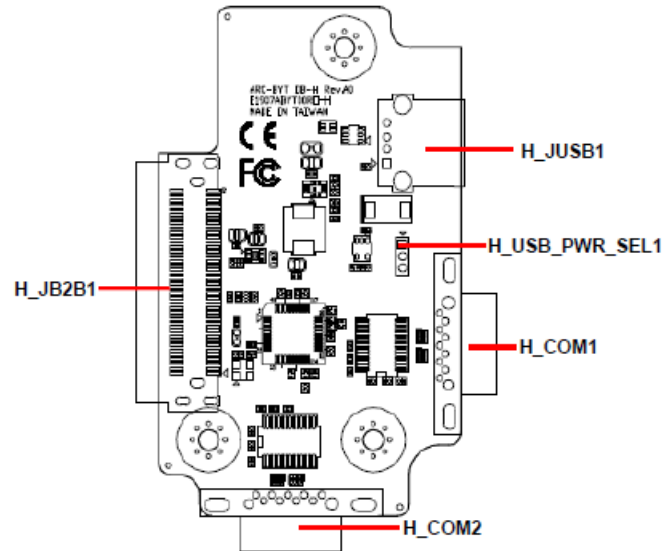

2.7.9 ARC-BYT DB-K

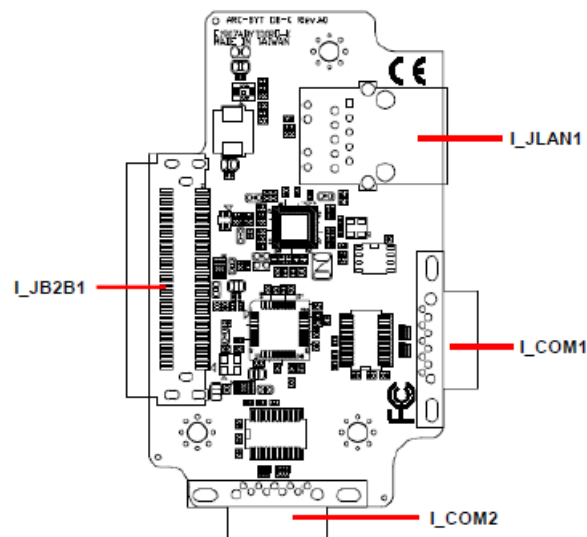

2.8 ARC-BYT DB-A/B/C/D/E/F/G/H/K Connector list

2.8.1 ARC-BYT DB-A

Connectors

Label	Function	Note
A_JUSB1~4	USB3.0 connector 1~4	
A_JB2B1	B2B connector	

2.8.2 ARC-BYT DB-B

Connectors

Label	Function	Note
B_LINE_OUT1	Line-out audio jack	
B_LINE_IN1	Line-in audio jack	
B_MIC_IN1	Mic-in audio jack	
B_JHDMI1	HDMI connector	
B_JB2B1	B2B connector	

2.8.3 ARC-BYT DB-C

Connectors

Label	Function	Note
C_JPCIE1	Mini PCI Express connector	
C_JSIM1	SIM card slot (Push-push)	
C_JHDMI1	HDMI connector	
C_JB2B1	B2B connector	

2.8.4 ARC-BYT DB-D

Connectors

Label	Function	Note
D_COM1/2	Serial Port 1/2 connector	DB-9 male connector
D_JB2B1	B2B connector	

2.8.5 ARC-BYT DB-E

Jumpers

Label	Function	Note
E_JCAN20	CAN2.0 Switch	3 x 1 header, pitch 2.00mm
E_JIAP1	For user update FW	3 x 1 header, pitch 2.00mm

E_JBOOT0	For user update FW	3 x 1 header, pitch 2.00mm
-----------------	--------------------	----------------------------

Connectors

Label	Function	Note
E_GPIO1	General purpose I/O connector	14 x 1 terminal, pitch 2.50mm
E_CN1	For user update FW	5 x 1 header, pitch 2.54mm
E_CAN1	CAN Bus connector	3 x 1 terminal, pitch 2.50mm
E_JB2B1	B2B connector	

2.8.6 ARC-BYT DB-F

Connectors

Label	Function	Note
F_CAN1	CAN Bus connector 1	7 x 2 header, pitch 2.00mm
F_CAN2	CAN Bus connector 2	
F_JB2B1	B2B connector	

2.8.7 ARC-BYT DB-G

Connectors

Label	Function	Note
G_COM1/2/3	Serial Port 1/2/3 connector	DB-9 male connector
G_JB2B1	B2B connector	

2.8.8 ARC-BYT DB-H

Jumpers

Label	Function	Note
H_USB_PWR_SEL1	USB Power selector	3 x 1 header, pitch 2.00mm

Connectors

Label	Function	Note
H_JUSB1	USB3.0 connector	
H_COM1/2	Serial Port 1/2 connector	DB-9 male connector
H_JB2B1	B2B connector	

2.8.9 ARC-BYT DB-K

Connectors

Label	Function	Note
-------	----------	------

ARC-10W33

I_JLAN1	RJ-45 Ethernet	
I_COM1/2	Serial Port 1/2 connector	DB-9 male connector
I_JB2B1	B2B connector	

2.9 ARC-BYT DB-D Connectors settings

2.9.1 Serial Port 1 connector (D_COM1)

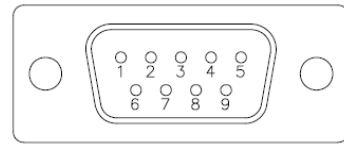
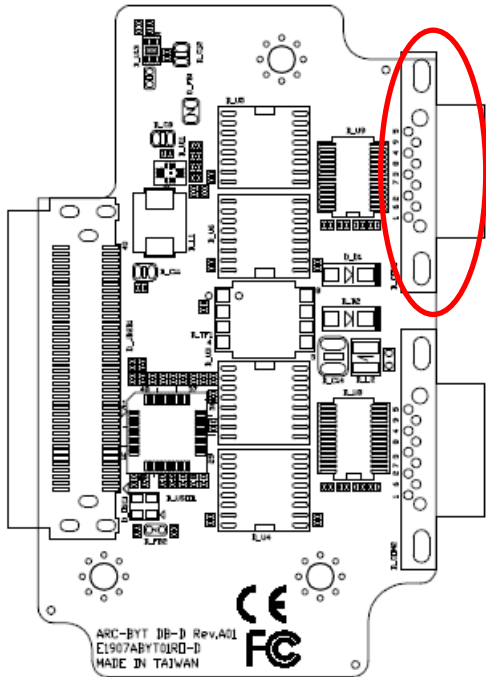

Signal	PIN	PIN	Signal
NDCD#_3_D	1	6	NDSR#_3_D
NRXD_3_D	2	7	NRTS#_3_D
NTXD_3_D	3	8	NCTS#_3_D
NDTR#_3_D	4	9	NRI#_3_D
GND	5		

2.9.2 Serial Port 2 connector (D_COM2)

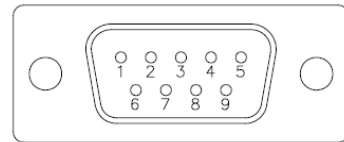
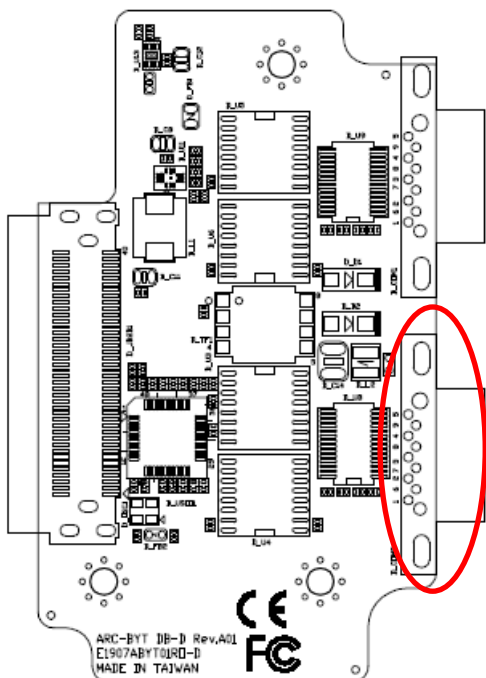

Signal	PIN	PIN	Signal
NDCD#_2_D	1	6	NDSR#_2_D
NRXD_2_D	2	7	NRTS#_2_D
NTXD_2_D	3	8	NCTS#_2_D
NDTR#_2_D	4	9	NRI#_2_D
GND	5		

2.10 ARC-BYT DB-E Jumpers & Connectors settings

2.10.1 CAN2.0 Switch (E_JCAN20)

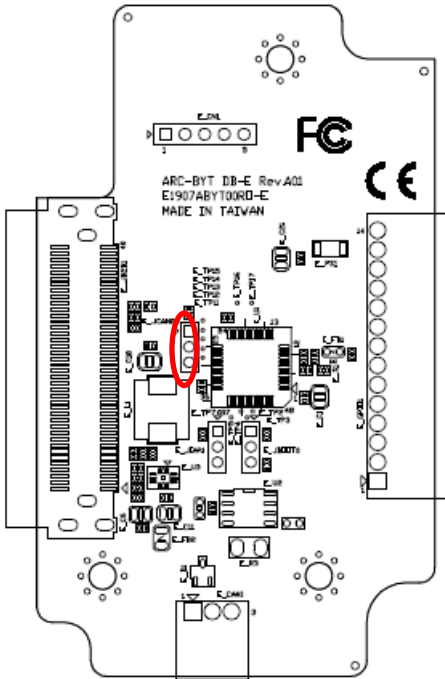

CAN2.0A (11-bit)*

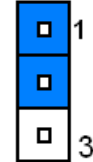

CAN2.0B (29-bit)

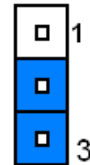

*Default

2.10.2 For user update FW (E_JBOOT0)

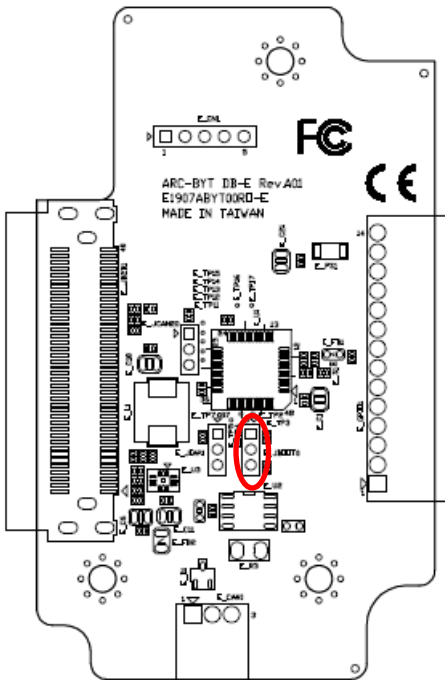

Default*

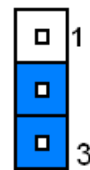

For user update FW

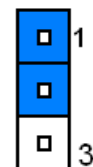

*Default

2.10.3 For user update FW (E_JIAP1)

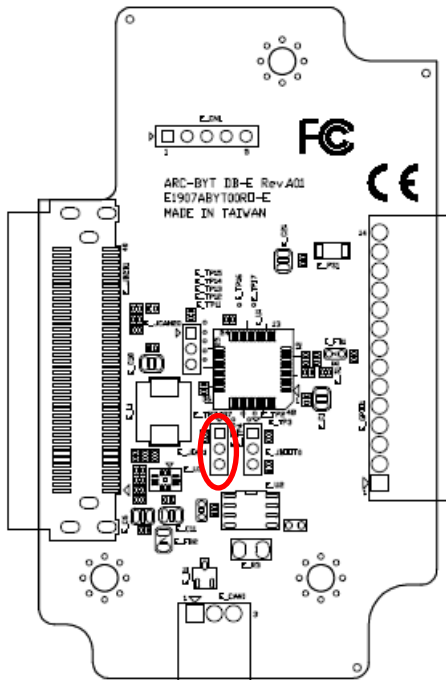

Default*

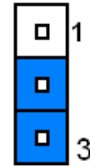

For user update FW

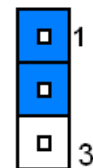

*Default

2.10.4 For user update FW (E_CN1)

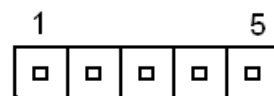
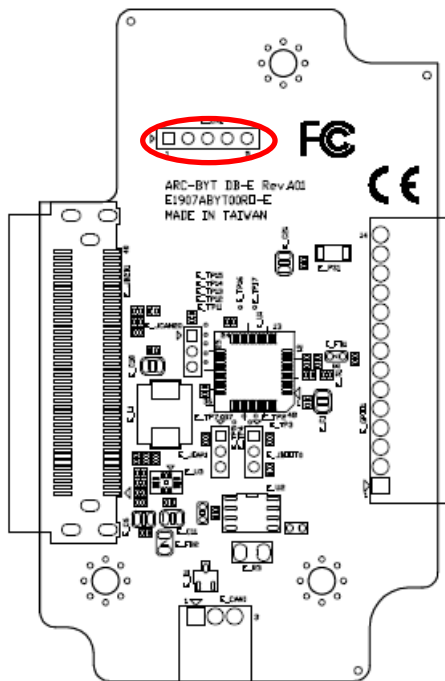

Signal	PIN
+3.3V	1
SWDIO	2
SWCLK	3
CAN_BUS_RESET#	4
GND	5

2.10.5 General purpose I/O connector (E_GPIO1)

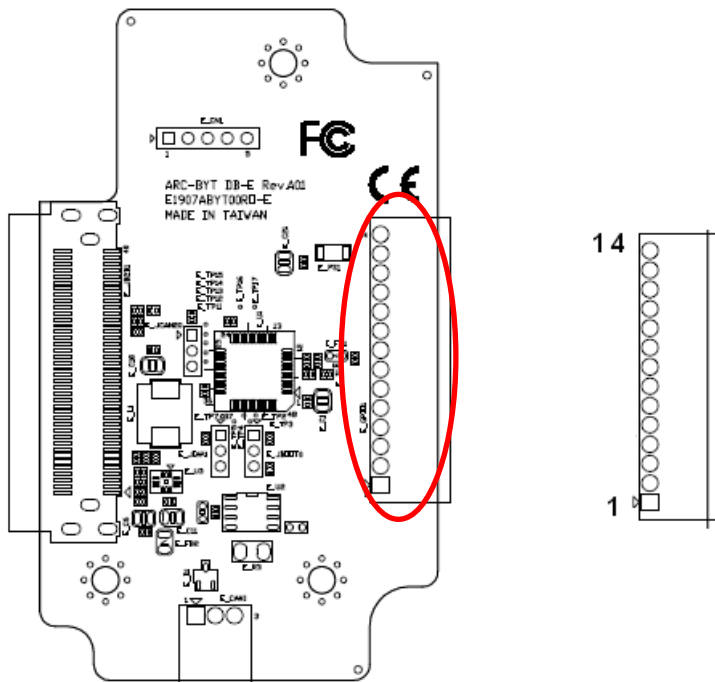

Signal	PIN
GND	14
+3.3V	13
DO5	12
DO4	11
DO3	10
DO2	9
DO1	8
DO0	7
DI5	6
DI4	5
DI3	4
DI2	3
DI1	2
DI0	1

2.10.6 CAN Bus connector (E_CAN1)

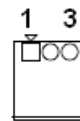
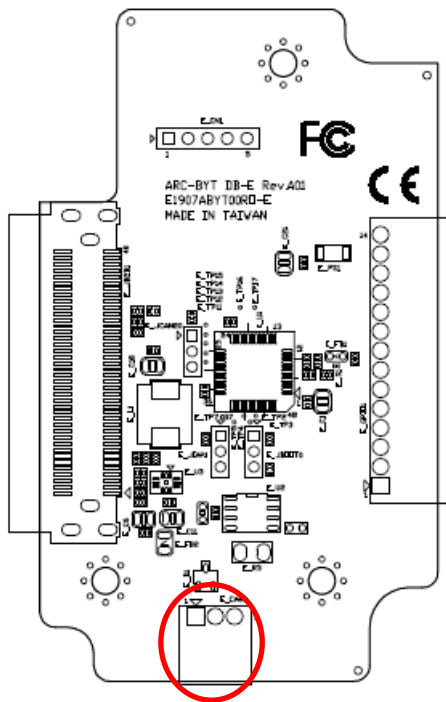

Signal	PIN
CANH	1
CANL	2
GND	3

2.11 ARC-BYT DB-F Connectors settings

2.11.1 CAN Bus connector 1 (F_CAN1)

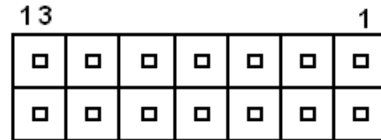
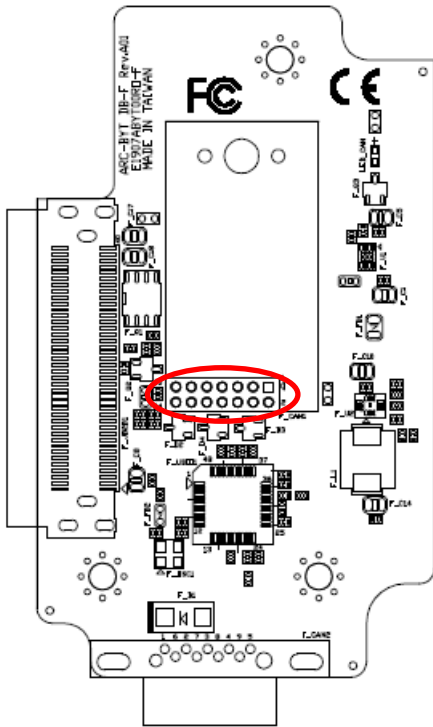

Signal	PIN	PIN	Signal
CAN_PWR	1	2	CAN_8
CAN_IND	3	4	CAN_9
GND	5	6	BAT_GND
CAN_WAKE	7	8	CAN_11
UART_RXD_1_F	9	10	CAN_12
UART_TXD_1_F	11	12	CAN_13
+5V	13	14	CAN_14

2.11.2 CAN Bus connector 2 (F_CAN2)

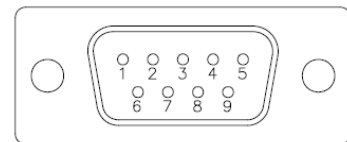
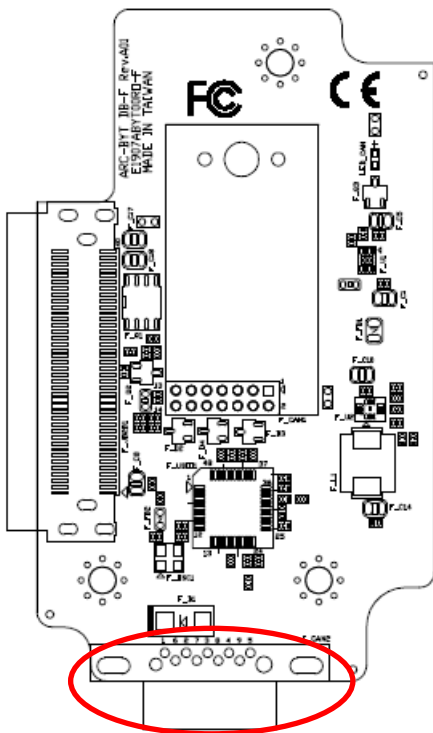

Signal	PIN	PIN	Signal
BAT_PWR	1	6	CAN_12
CAN_8	2	7	CAN_13
CAN_9	3	8	CAN_14
BAT_GND	4	9	NC
CAN_11	5		

2.12 ARC-BYT DB-G Connectors settings

2.12.1 Serial Port 1 connector (G_COM1)

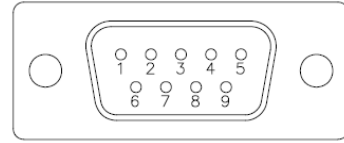
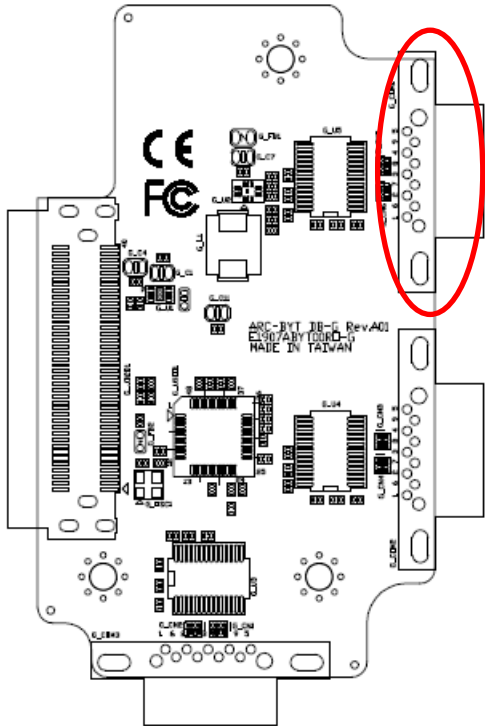

Signal	PIN	PIN	Signal
NDCD#_3_G	1	6	NDSR#_3_G
NRXD_3_G	2	7	NRTS#_3_G
NTXD_3_G	3	8	NCTS#_3_G
NDTR#_3_G	4	9	NRI#_3_G
GND	5		

2.12.2 Serial Port 2 connector (G_COM2)

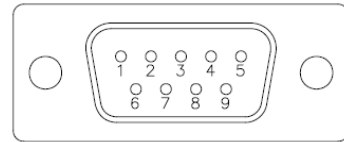
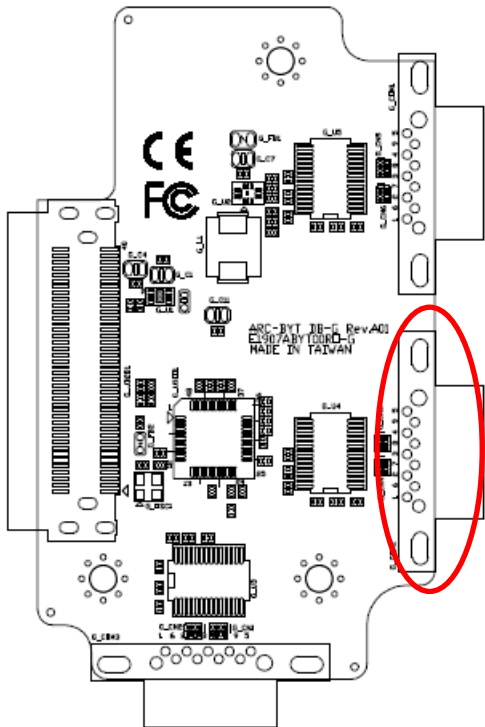

Signal	PIN	PIN	Signal
NDCD#_2_G	1	6	NDSR#_2_G
NRXD_2_G	2	7	NRTS#_2_G
NTXD_2_G	3	8	NCTS#_2_G
NDTR#_2_G	4	9	NRI#_2_G
GND	5		

2.12.3 Serial Port 3 connector (G_COM3)

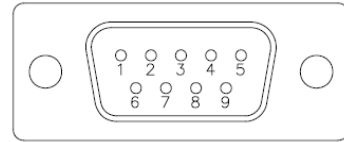
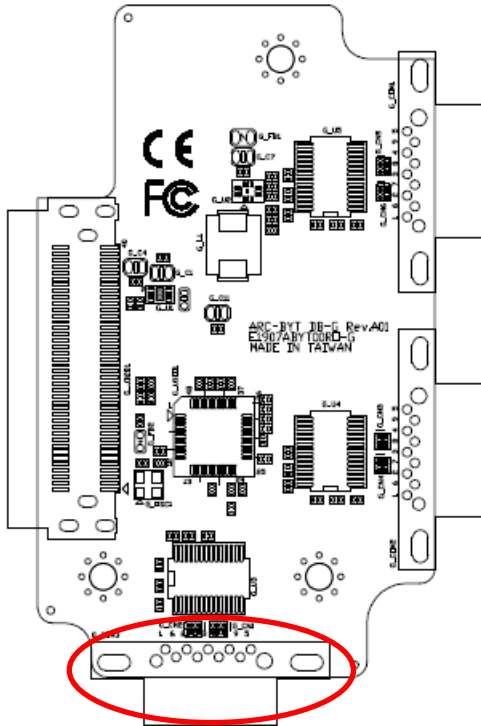

Signal	PIN	PIN	Signal
NDCD#_1_G	1	6	NDSR#_1_G
NRXD_1_G	2	7	NRTS#_1_G
NTXD_1_G	3	8	NCTS#_1_G
NDTR#_1_G	4	9	NRI#_1_G
GND	5		

2.13 ARC-BYT DB-H Jumpers settings

2.13.1 USB Power selector (H_USB_PWR_SEL1)

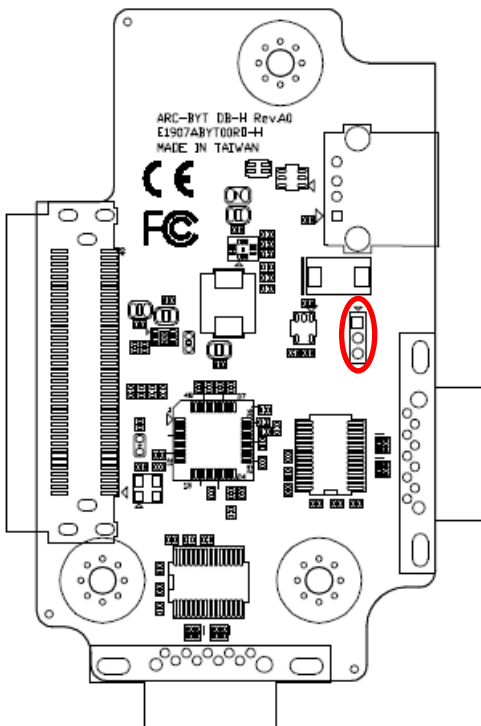

+5VSB*

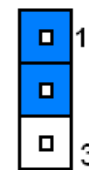

+5V

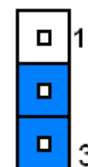

*Default

2.14 ARC-BYT DB-H Connectors settings

2.14.1 Serial Port 1 connector (H_COM1)

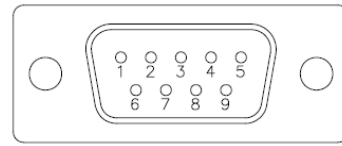
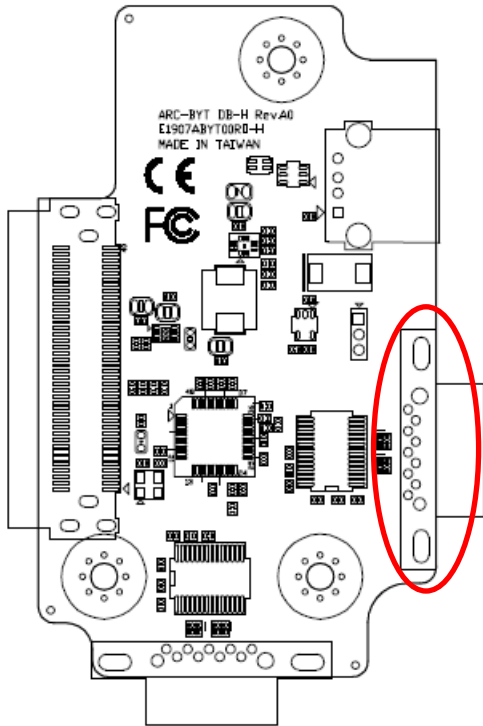

Signal	PIN	PIN	Signal
NDCD#_1_H	1	6	NDSR#_1_H
NRXD_1_H	2	7	NRTS#_1_H
NTXD_1_H	3	8	NCTS#_1_H
NDTR#_1_H	4	9	NRI#_1_H
GND	5		

2.14.2 Serial Port 2 connector (H_COM2)

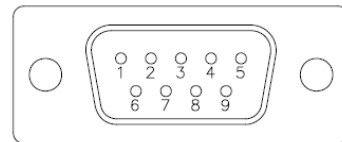
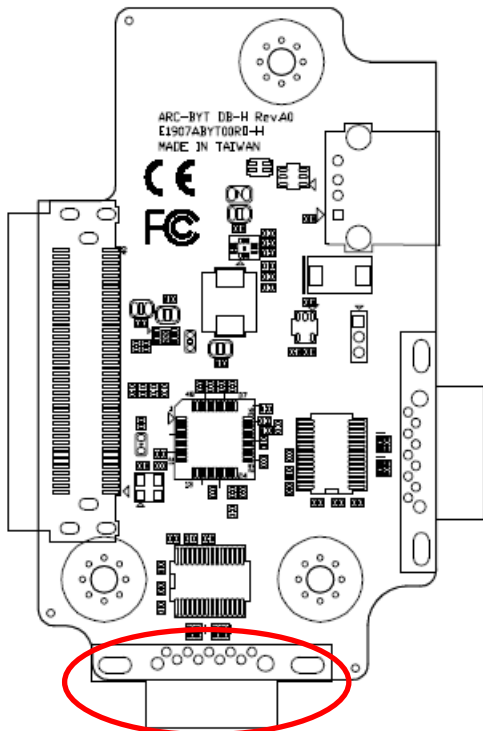

Signal	PIN	PIN	Signal
NDCD#_2_H	1	6	NDSR#_2_H
NRXD_2_H	2	7	NRTS#_2_H
NTXD_2_H	3	8	NCTS#_2_H
NDTR#_2_H	4	9	NRI#_2_H
GND	5		

2.15 ARC-BYT DB-K Connectors settings

2.15.1 Serial Port 1 connector (I_COM1)

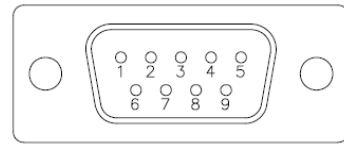
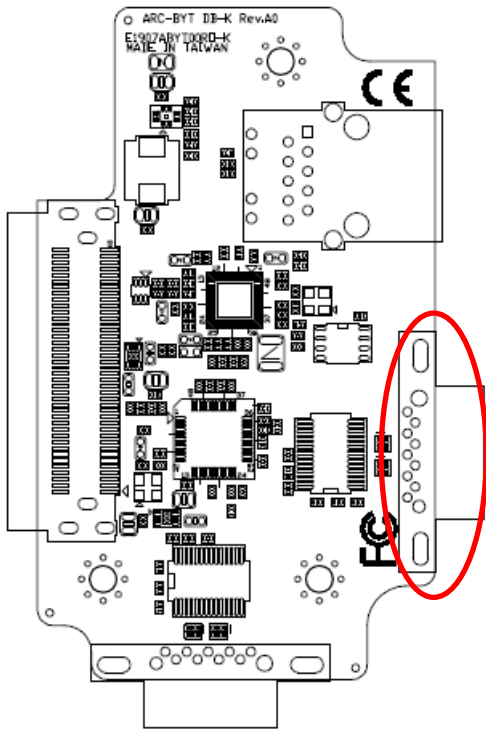

Signal	PIN	PIN	Signal
NDCD#_1_I	1	6	NDSR#_1_I
NRXD_1_I	2	7	NRTS#_1_I
NTXD_1_I	3	8	NCTS#_1_I
NDTR#_1_I	4	9	NRI#_1_I
GND	5		

2.15.2 Serial Port 2 connector (I_COM2)

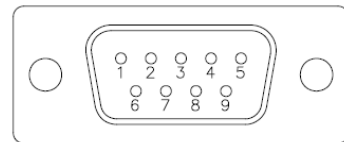
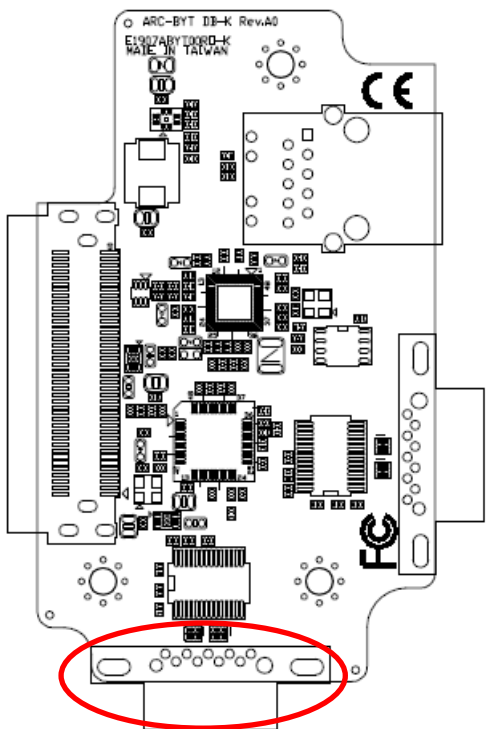

Signal	PIN	PIN	Signal
NDCD#_2_I	1	6	NDSR#_2_I
NRXD_2_I	2	7	NRTS#_2_I
NTXD_2_I	3	8	NCTS#_2_I
NDTR#_2_I	4	9	NRI#_2_I
GND	5		

3. BIOS Setup

3.1 Introduction

The AMI setup program allows users to modify the basic system configuration. In this following chapter will describe how to access the BIOS setup program and the configuration options that may be changed.

3.2 Starting Setup

The AMI BIOS™ is immediately activated when you first power on the computer. The BIOS reads the system information contained in the NVRAM and begins the process of checking out the system and configuring it. When it finishes, the BIOS will seek an operating system on one of the disks and then launch and turn control over to the operating system.

While the BIOS is in control, the Setup program can be activated in one of two ways:

By pressing or <F2> immediately after switching the system on, or

By pressing the or <F2> key when the following message appears briefly at the left-top of the screen during the POST (Power On Self Test).

Press or <F2> to enter SETUP

If the message disappears before you respond and you still wish to enter Setup, restart the system to try again by turning it OFF then ON or pressing the "RESET" button on the system case. You may also restart by simultaneously pressing <Ctrl>, <Alt>, and <Delete> keys. If you do not press the keys at the correct time and the system does not boot, an error message will be displayed and you will again be asked to.

Press F1 to Continue, DEL to enter SETUP

3.3 Using Setup

In general, you use the arrow keys to highlight items, press <Enter> to select, use the PageUp and PageDown keys to change entries, press <F1> for help and press <Esc> to quit. The following table provides more detail about how to navigate in the Setup program using the keyboard.

Button	Description
↑	Move to previous item
↓	Move to next item
←	Move to the item in the left hand
→	Move to the item in the right hand
Esc key	Main Menu -- Quit and not save changes into NVRAM Status Page Setup Menu and Option Page Setup Menu -- Exit current page and return to Main Menu
+ key	Increase the numeric value or make changes
- key	Decrease the numeric value or make changes
F1 key	General help, only for Status Page Setup Menu and Option Page Setup Menu
F2 key	Previous Values.
F3 key	Optimized defaults
F4 key	Save & Exit Setup

- **Navigating Through The Menu Bar**

Use the left and right arrow keys to choose the menu you want to be in.



Note: Some of the navigation keys differ from one screen to another.

- **To Display a Sub Menu**

Use the arrow keys to move the cursor to the sub menu you want. Then press <Enter>. A “➤” pointer marks all sub menus.

3.4 Getting Help

Press F1 to pop up a small help window that describes the appropriate keys to use and the possible selections for the highlighted item. To exit the Help Window press <Esc> or the F1 key again.

3.5 In Case of Problems

If, after making and saving system changes with Setup, you discover that your computer no longer is able to boot, the AMI BIOS supports an override to the NVRAM settings which resets your system to its defaults.

The best advice is to only alter settings which you thoroughly understand. To this end, we strongly recommend that you avoid making any changes to the chipset defaults. These defaults have been carefully chosen by both BIOS Vendor and your systems manufacturer to provide the absolute maximum performance and reliability. Even a seemingly small change to the chipset setup has the potential for causing you to use the override.

3.6 BIOS setup

Once you enter the Aptio Setup Utility, the Main Menu will appear on the screen. The Main Menu allows you to select from several setup functions and exit choices. Use the arrow keys to select among the items and press <Enter> to accept and enter the sub-menu.

3.6.1 Main Menu

This section allows you to record some basic hardware configurations in your computer and set the system clock.

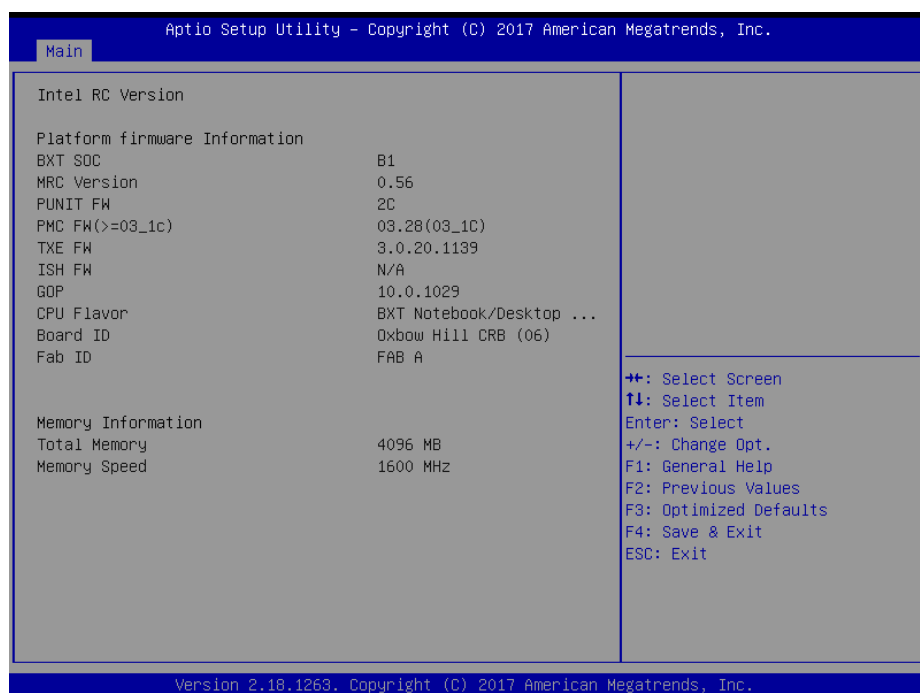
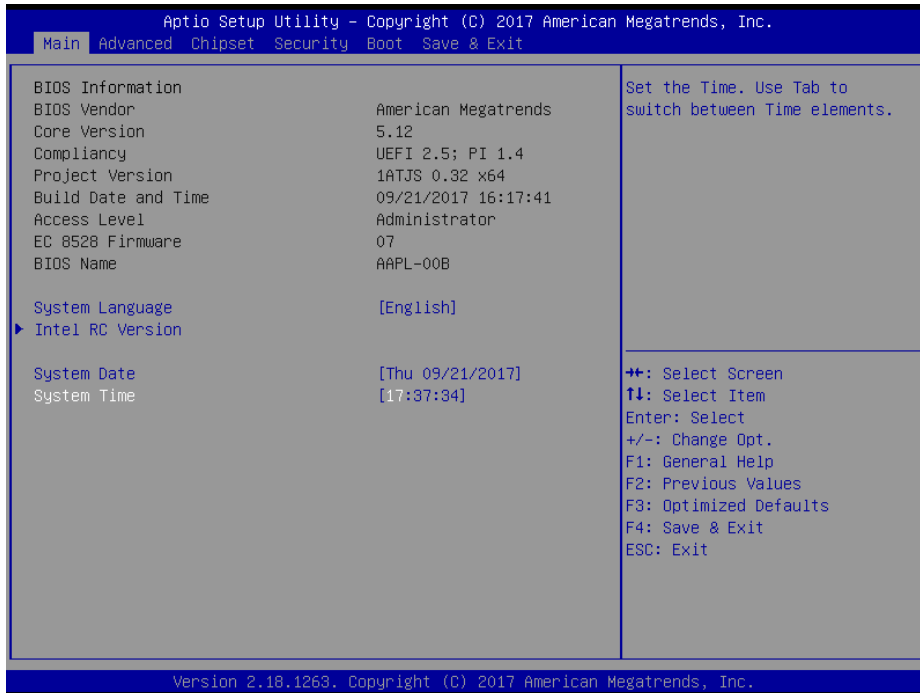

3.6.1.1 System Language

This option allows choosing the system default language.

3.6.1.2 System Date

Use the system date option to set the system date. Manually enter the day, month and year.

3.6.1.3 System Time

Use the system time option to set the system time. Manually enter the hours, minutes and seconds.



Note: The BIOS setup screens shown in this chapter are for reference purposes only, and may not exactly match what you see on your screen. Visit the Avalue website (www.avalue.com.tw) to download the latest product and BIOS information.

3.6.2 Advanced Menu

This section allows you to configure your CPU and other system devices for basic operation through the following sub-menus.

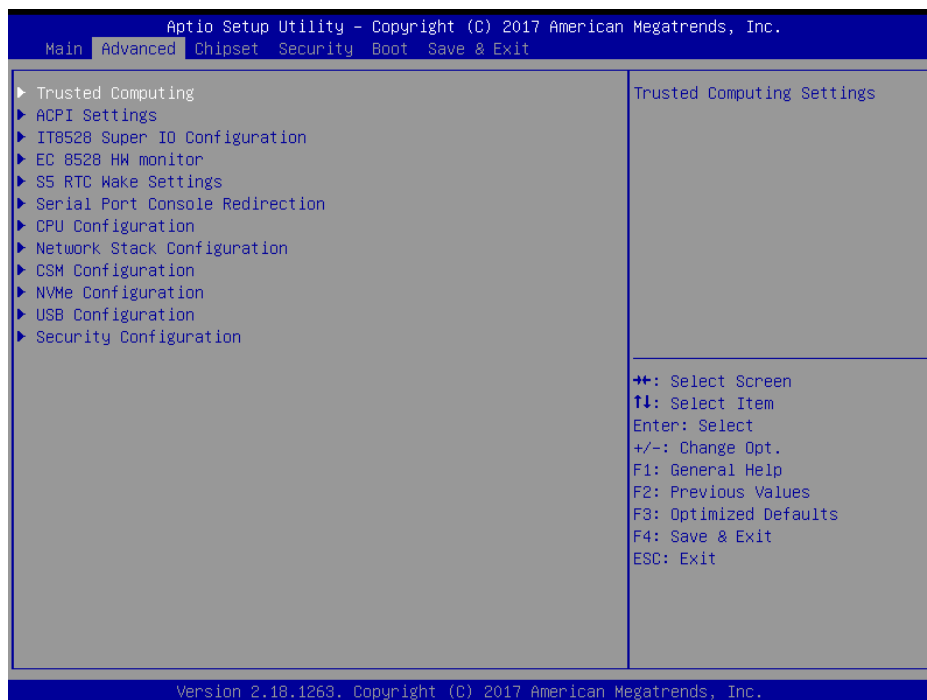

3.6.2.1 Trusted Computing



Item	Options	Description
Security Device Support	Disable, Enable[Default]	Enables or Disables BIOS support for security device. O.S. will not show Security Device. TCG EFI protocol and INT1A interface will not be available.
Physical Presence Spec Version	1.2 1.3[Default]	Select to Tell O.S. to support PPI Spec Version 1.2 or 1.3 Note some HCK tests might not support 1.3.

3.6.2.2 ACPI Settings



Quick Reference Guide

Item	Options	Description
Enable Hibernation	Disabled Enabled[Default],	Enables or Disables System ability to Hibernate (OS/S4 Sleep State). This option may be not effective with some OS.
ACPI Sleep State	Suspend Disabled, S3 (Suspend to RAM)[Default]	Select the highest ACPI sleep state the system will enter when the SUSPEND button is pressed.
ErP Function	Disabled[Default], Enabled	ErP Function (Deep S5).
PWR-On After PWR-Fail	Off[Default] On Last state	AC loss resume.
Watch Dog	Disabled[Default], 30 sec 40 sec 50 sec 1 min 2 min 10 min 30 min	Select WatchDog.
USB Standby Power Setting	Disabled Enabled[Default],	Enabled/Disabled USB Standby Power during S3/S4/S5.
Wake Up by Ring	Disabled Enabled[Default],	Wake Up by Ring from S3/S4/S5.

3.6.2.3 IT8528 Super IO Configuration

You can use this item to set up or change the IT8528 Super IO configuration for serial ports. Please refer to 3.6.2.3.1~ 3.6.2.3.5 for more information.

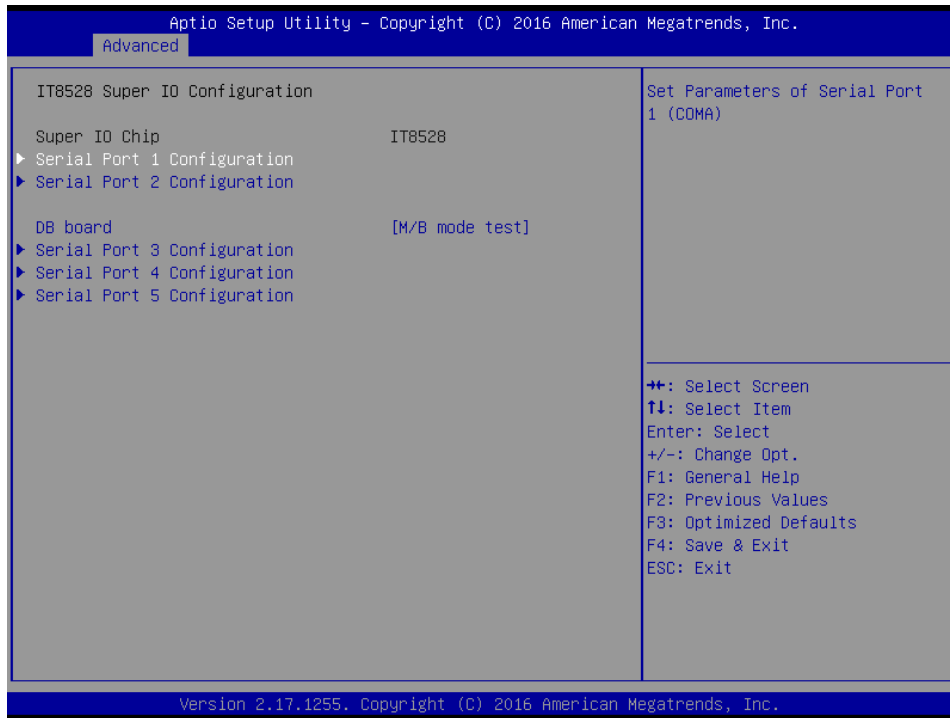

Item	Options	Description
DB board	DB-A/C/E/J DB-B DB-F 1COM DB-D/H/K 2COM DB-G 3COM M/B mode test[Default],	DB board A-K. DA-A/B/C/E/J w/o UART DB-G w/t 3UART DB-D/H/K w/t 2UART DB-F w/t 1UART.
Serial Port 1 Configuration	Set Parameters of Serial Port 1 (COMA).	
Serial Port 2 Configuration	Set Parameters of Serial Port 2 (COMB).	
Serial Port 3 Configuration	Set Parameters of Serial Port 3 (COMC).	
Serial Port 4 Configuration	Set Parameters of Serial Port 4 (COMD).	
Serial Port 5 Configuration	Set Parameters of Serial Port 5 (COME).	

3.6.2.3.1 Serial Port 1 Configuration

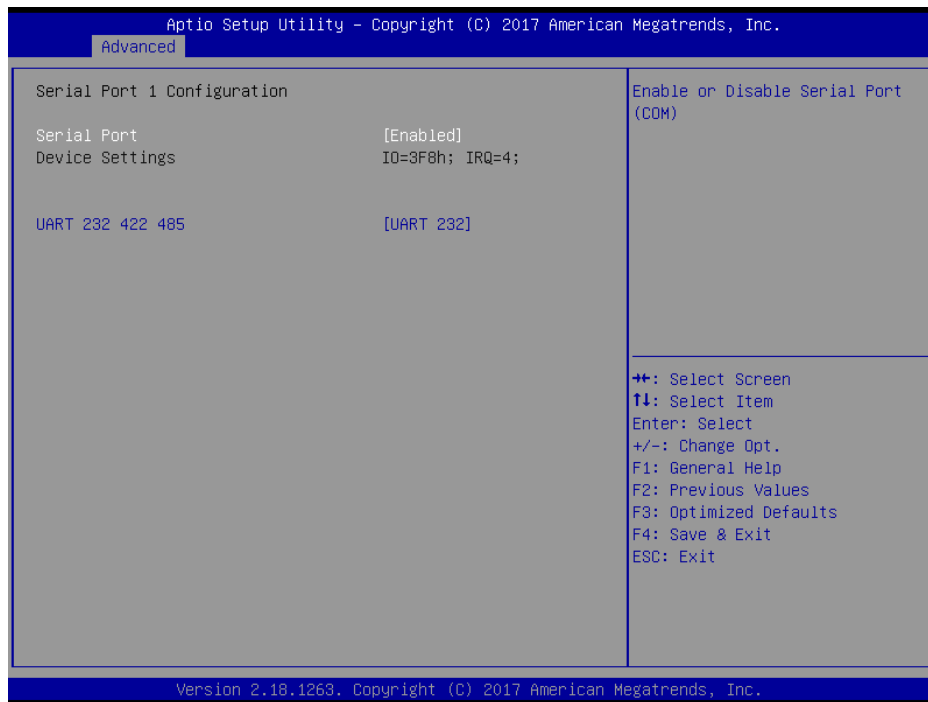

Item	Option	Description
Serial Port	Enabled[Default], Disabled	Enable or Disable Serial Port (COM).
UART 232 422 485	UART 232[Default] UART 422 UART 485	Change the Serial Port

3.6.2.3.2 Serial Port 2 Configuration

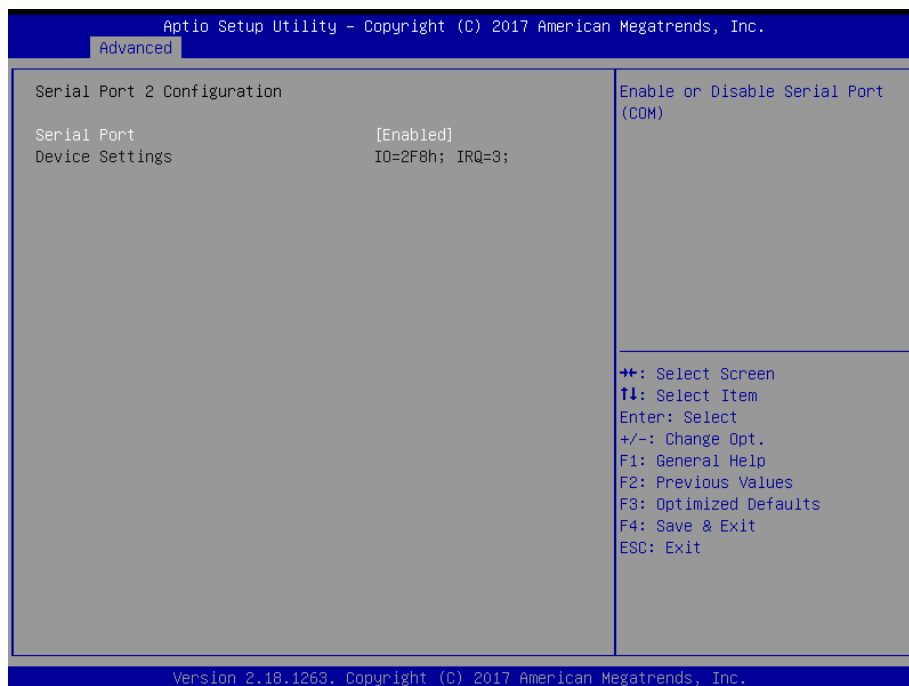

ARC-10W33

Item	Option	Description
Serial Port	Enabled[Default], Disabled	Enable or Disable Serial Port (COM).

3.6.2.3.3 Serial Port 3 Configuration

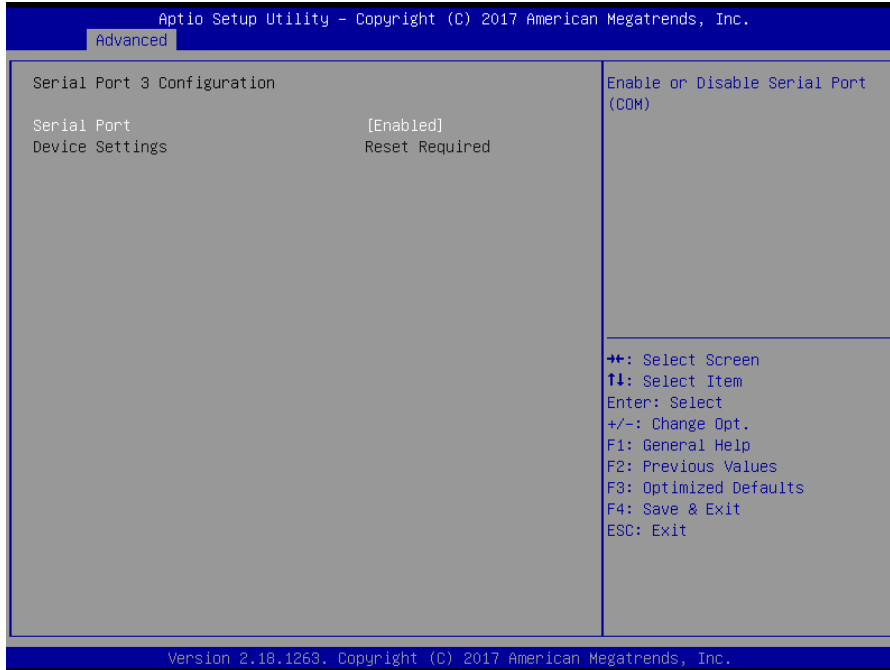

Item	Option	Description
Serial Port	Enabled[Default], Disabled	Enable or Disable Serial Port (COM).

3.6.2.3.4 Serial Port 4 Configuration

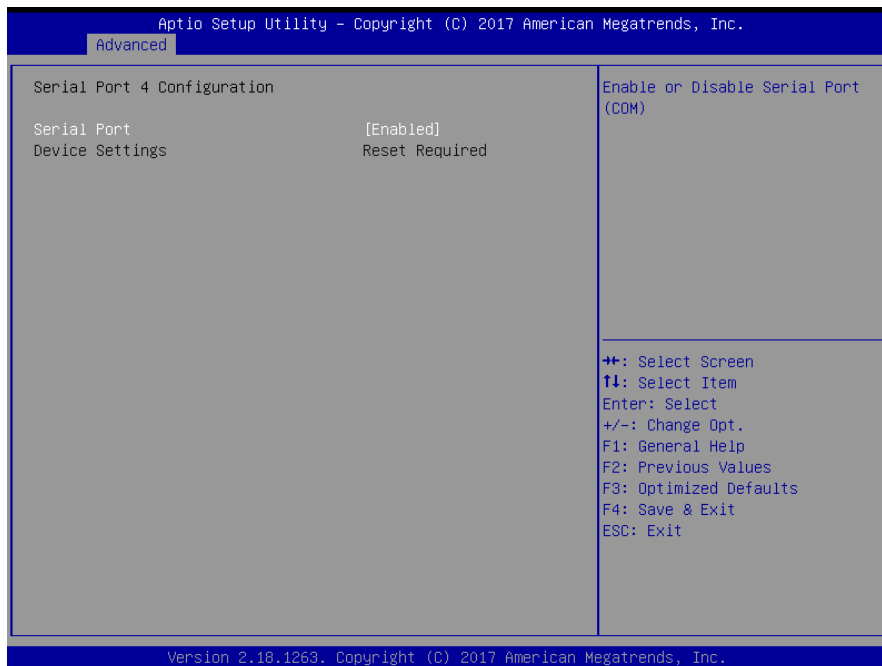

Item	Option	Description
Serial Port	Enabled[Default], Disabled	Enable or Disable Serial Port (COM).

3.6.2.3.5 Serial Port 5 Configuration

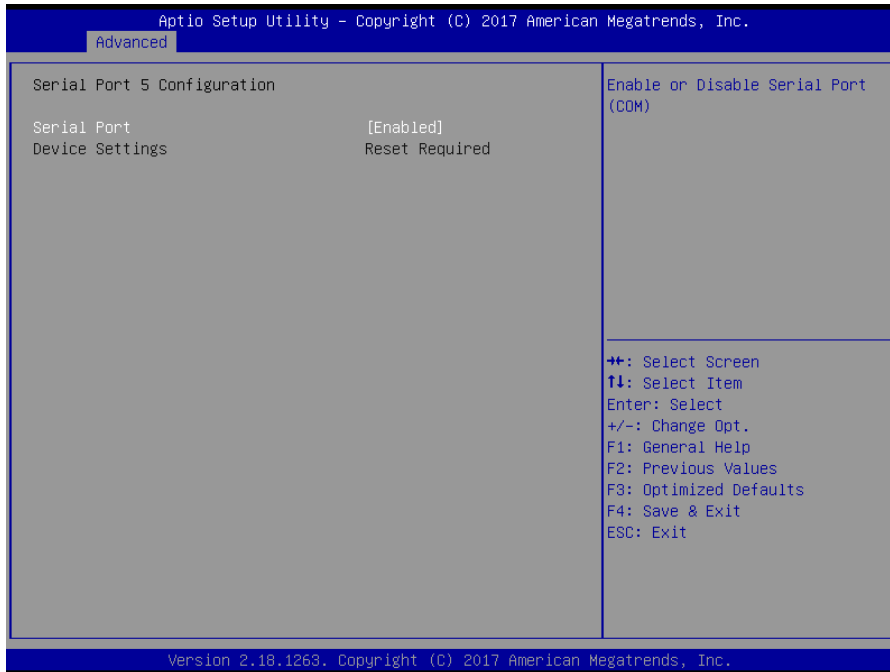

Item	Option	Description
Serial Port	Enabled[Default], Disabled	Enable or Disable Serial Port (COM).

3.6.2.4 H/W Monitor

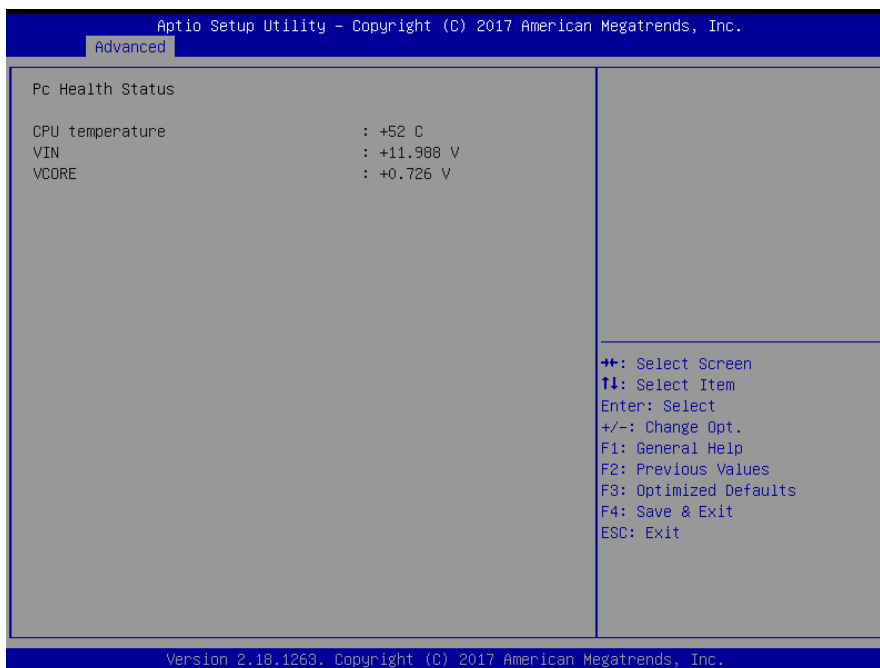

3.6.2.5 S5 RTC Wake Settings

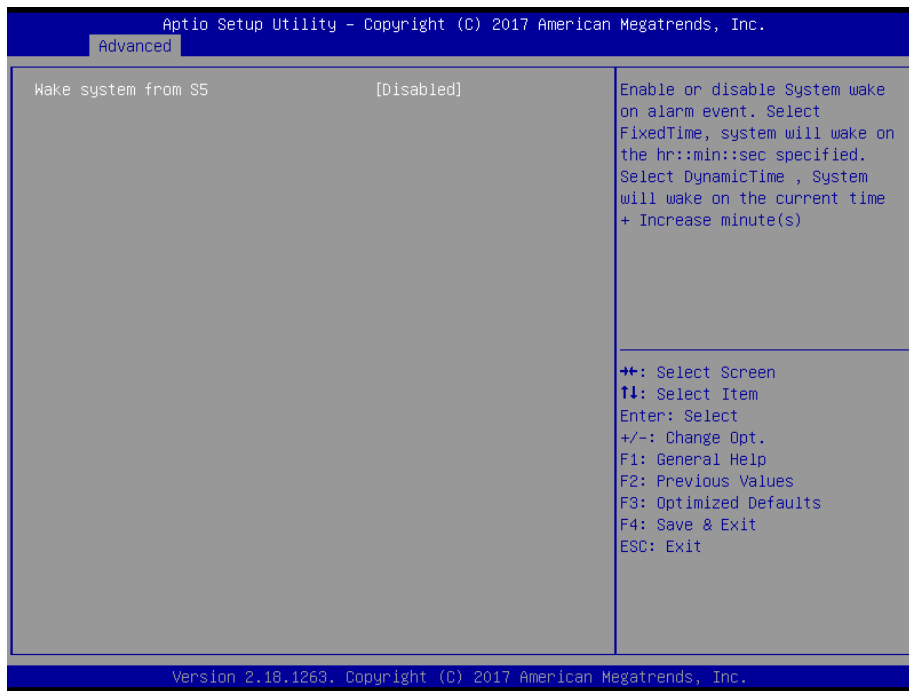

Item	Options	Description
Wake system from S5	Disabled[Default], Fixed Time Dynamic Time	Enable or disable System wake on alarm event. Select Fixed Time, system will wake on the hr::min::sec specified. Select Dynamic Time, System will wake on the current time + Increase minute(s).

3.6.2.6 Serial Port Console Redirection

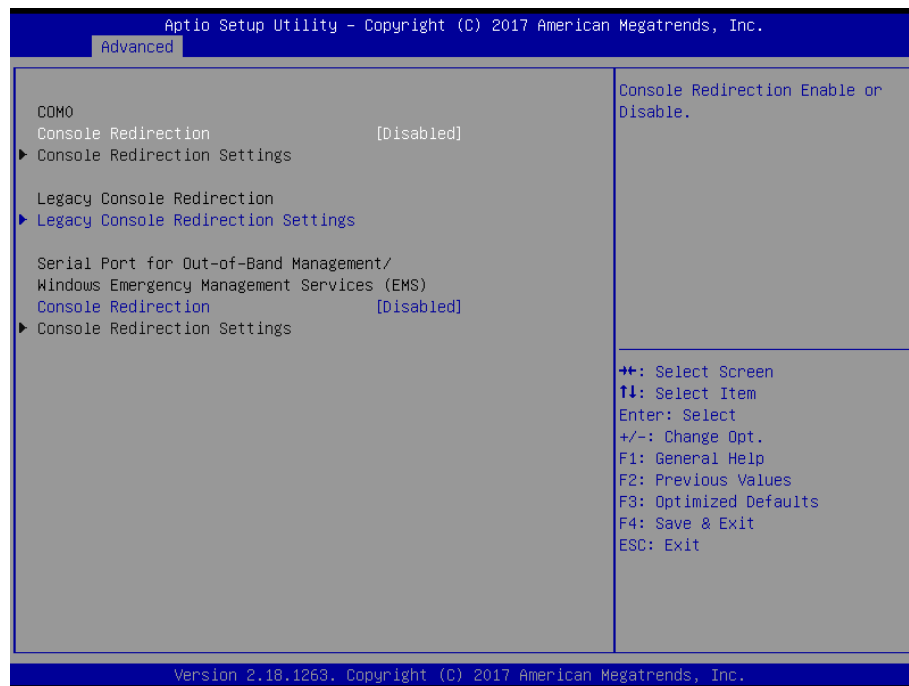

Item	Options	Description
Console Redirection	Disabled[Default], Enabled	Console Redirection Enable or Disable.

3.6.2.6.1 Legacy Console Redirection Settings



Item	Option	Description
Legacy Serial Redirection Port	COM0[Default],	Select a COM port to display redirection of Legacy OS and Legacy OPRM Messages.

3.6.2.7 CPU Configuration

Use the CPU configuration menu to view detailed CPU specification and configure the CPU.

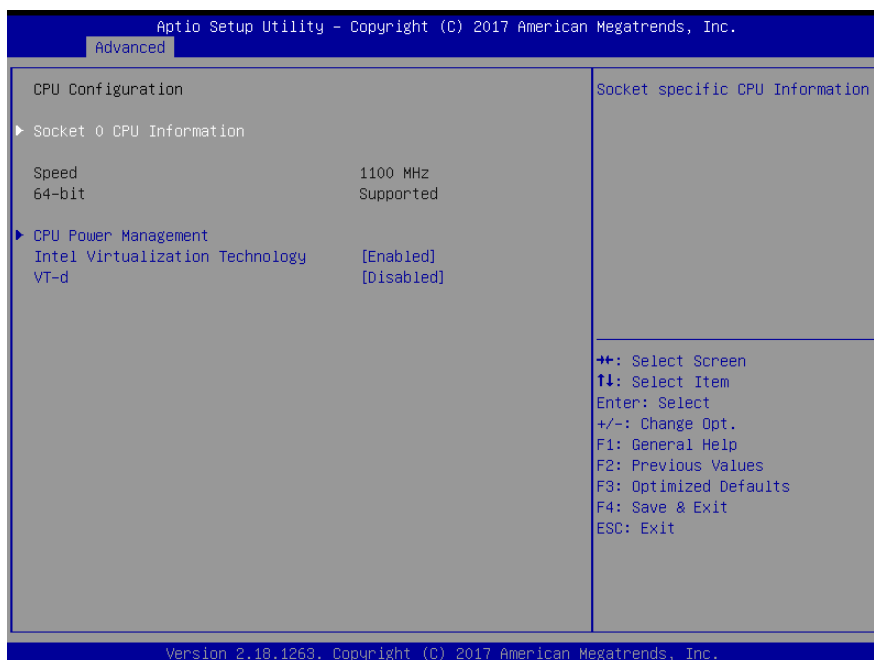

Item	Options	Description
Intel Virtualization Technology	Disabled, Enabled[Default]	When enabled, a VMM can utilize the additional hardware capabilities provided by Vanderpool Technology.
VT-d	Disabled[Default], Enabled	Enable/Disable CPU VT-d.

3.6.2.7.1 Socket 0 CPU Information

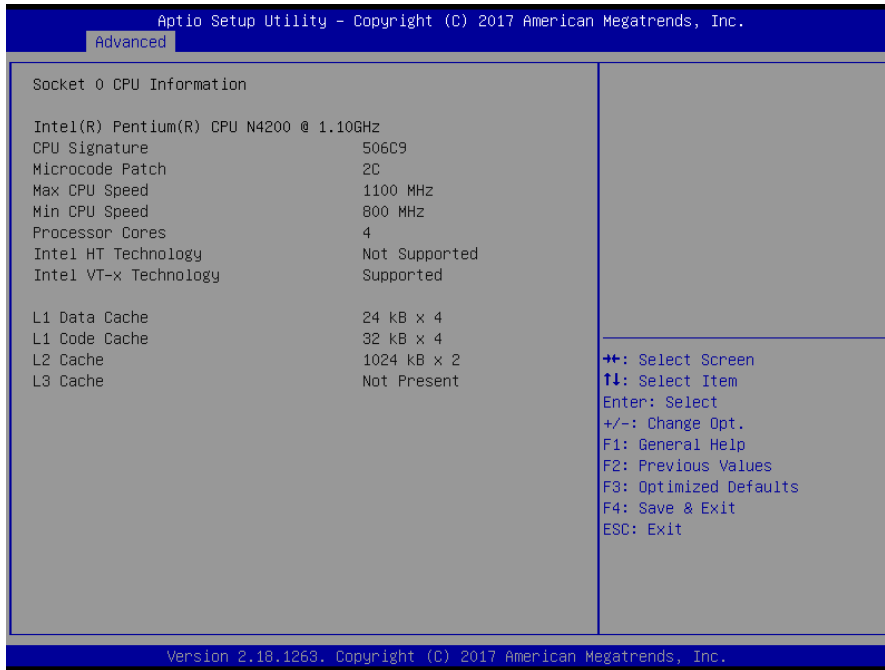

3.6.2.7.2 CPU Power Management Configuration

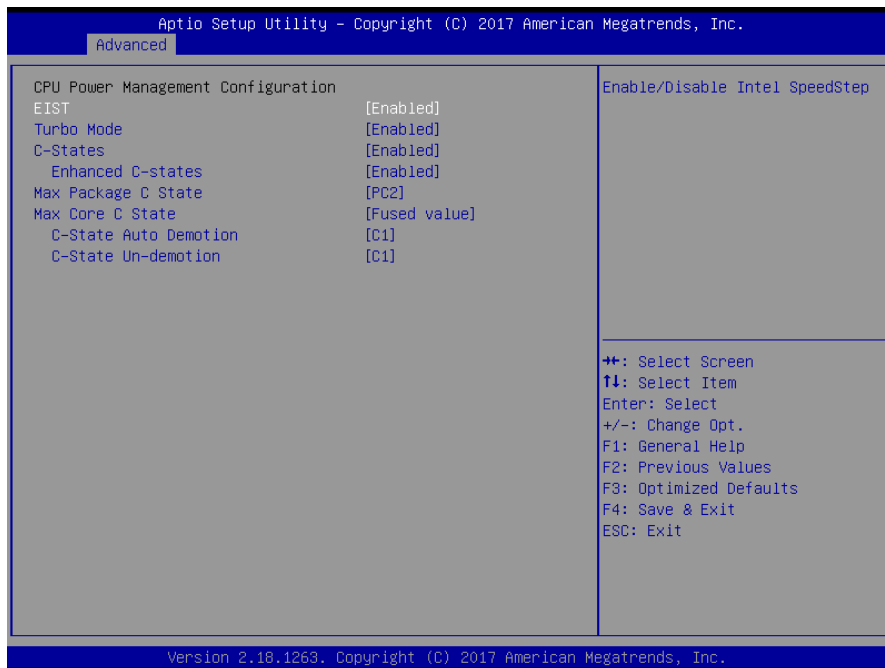

Item	Options	Description
EIST	Disabled, Enabled[Default]	Enable/Disable Intel SpeedStep.
Turbo Mode	Disabled, Enabled[Default]	Turbo Mode.
C-States	Disabled, Enabled[Default]	Enable/Disable C States.
Enhanced C-states	Disabled, Enabled[Default]	Enable/Disable C1E. When enabled, CPU will switch to minimum speed when all cores enter C-State.
Max Package C State	PC2[Default] PC1 C0	Controls the Max Package C State that the processor will support.
Max Core C State	Fused value[Default] Core C10 Core C9 Core C8 Core C7 Core C6 Core C1 Unlimited	This option controls the Max Core C State that cores will support.
C-State Auto Demotion	Disabled, C1[Default]	Configure C-State Auto Demotion.
C-State Un-demotion	Disabled, C1[Default]	Configure C-State Un-demotion.

3.6.2.8 Network Stack Configuration



Item	Options	Description
Network Stack	Enabled Disabled[Default]	Enable/Disable UEFI Network Stack.

3.6.2.9 CSM Configuration

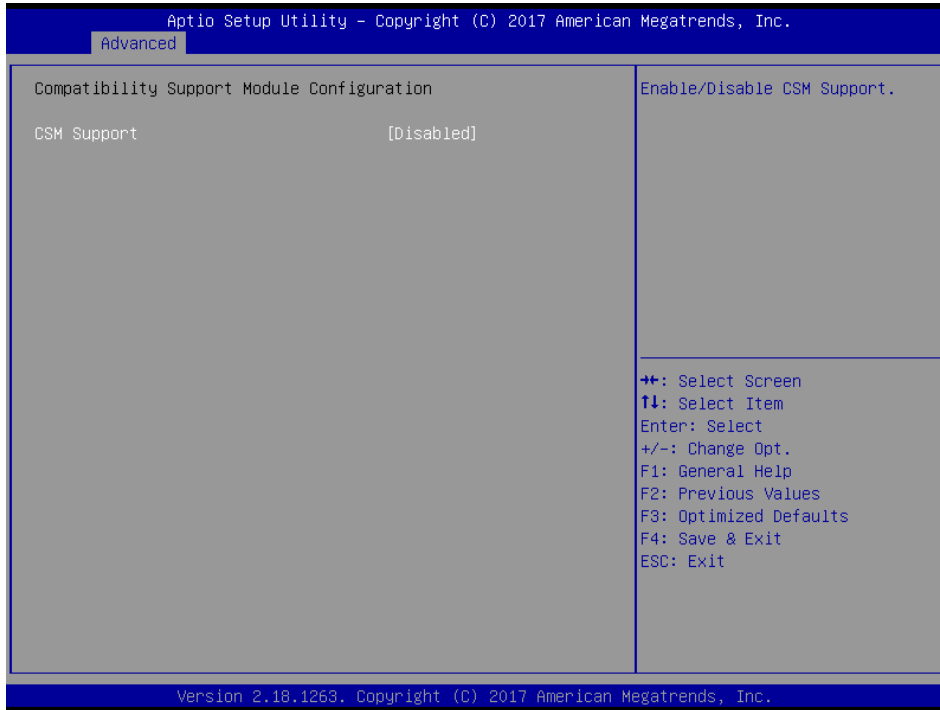

Item	Options	Description
CSM Support	Enabled Disabled[Default]	Enable/Disable CSM Support.

3.6.2.10 NVMe Configuration



3.6.2.11 USB Configuration

The USB Configuration menu helps read USB information and configures USB settings.

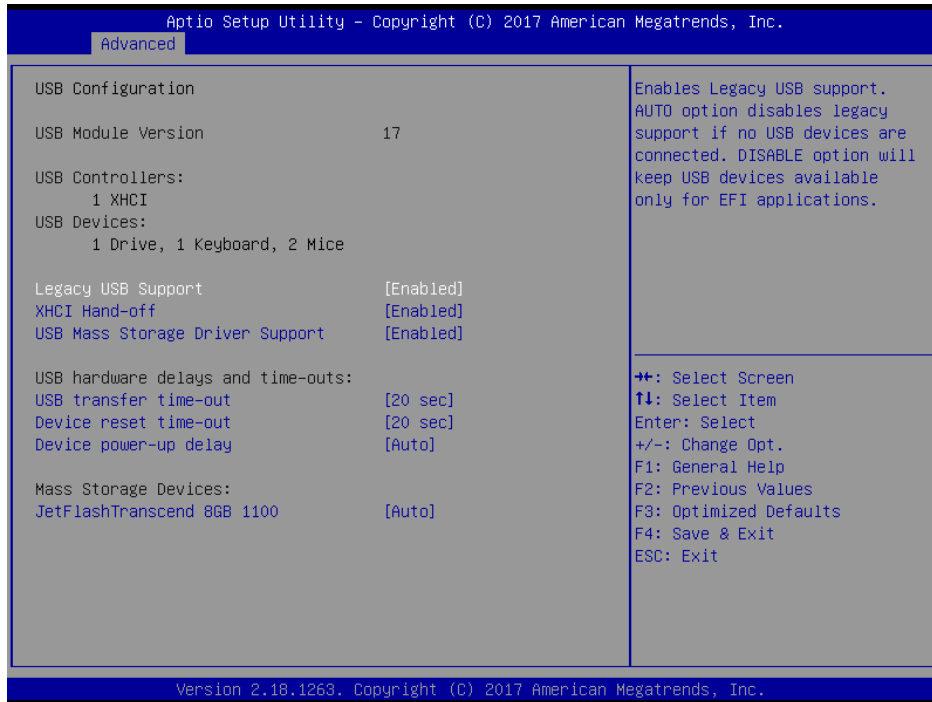

Item	Options	Description
Legacy USB Support	Enabled[Default] Disabled Auto	Enables Legacy USB support. AUTO option disables legacy support if no USB devices are connected. DISABLE option will keep USB devices available only for EFI applications.
XHCI Hand-off	Enabled[Default] Disabled	This is a workaround for Oses without XHCI hand-off support. The XHCI ownership change should be claimed by XHCI driver.
USB Mass Storage Driver Support	Enabled[Default] Disabled	Enable/Disable USB Mass Storage Driver Support.
USB transfer time-out	1 sec 5 sec 10 sec 20 sec[Default]	The time-out value for Control, Bulk, and Interrupt transfers.
Device reset time-out	10 sec 20 sec[Default] 30 sec 40 sec	USB mass storage device Start Unit command time-out.
Device power-up delay	Auto[Default] Manual	Maximum time the device will take before it properly reports itself to the Host Controller. 'Auto' uses default value: for a Root port it is 100ms, for a Hub port the delay is taken from Hub descriptor.
Mass Storage Devices	Auto[Default] Floppy Forced FDD Hard Disk CD-ROM	Mass storage device emulation type. 'AUTO' enumerates devices according to their media format. Optical drives are emulated as 'CDROM', drives with no media will be emulated according to a drive type.

3.6.2.12 Security Configuration

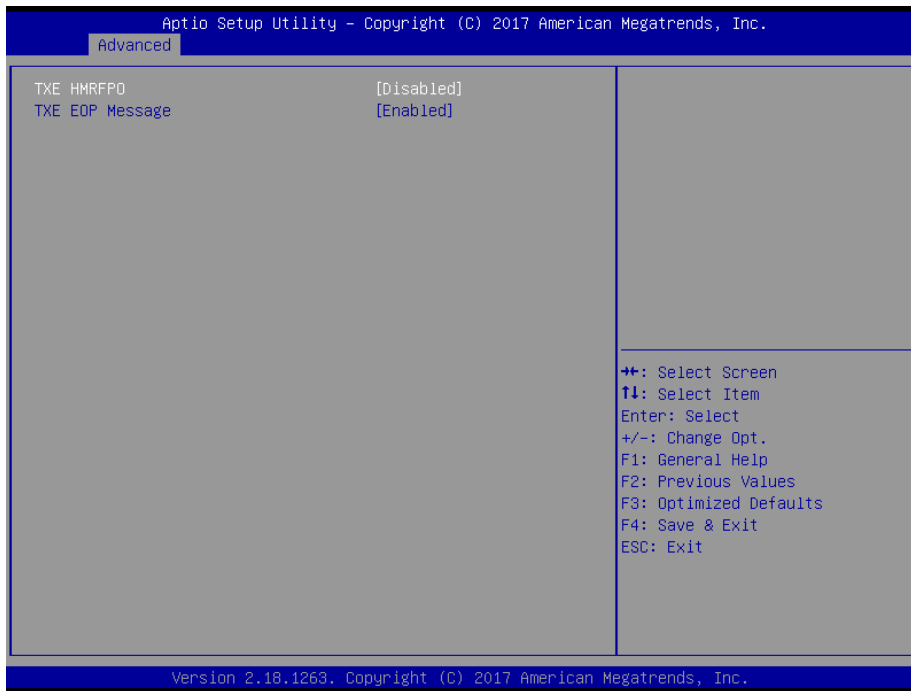

Item	Options	Description
TXE HMRFP0	Enabled Disabled [Default]	TXE HMRFP0.
TXE EOP Message	Enabled [Default] Disabled	Send EOP Message Before Enter OS.

3.6.3 Chipset



3.6.3.1 North Bridge



Item	Option	Description
Max TOLUD	2 GB[Default] 2.25 GB 2.5 GB 2.75 GB	Maximum Value of TOLUD.
Above 4GB MMIO BIOS assignment	Enabled Disabled[Default]	Enable/Disable above 4GB MemoryMappedIO BIOS assignment. This is disabled automatically when Aperture Size is set to 2048MB.

ARC-10W33

3.6.3.2 South Bridge

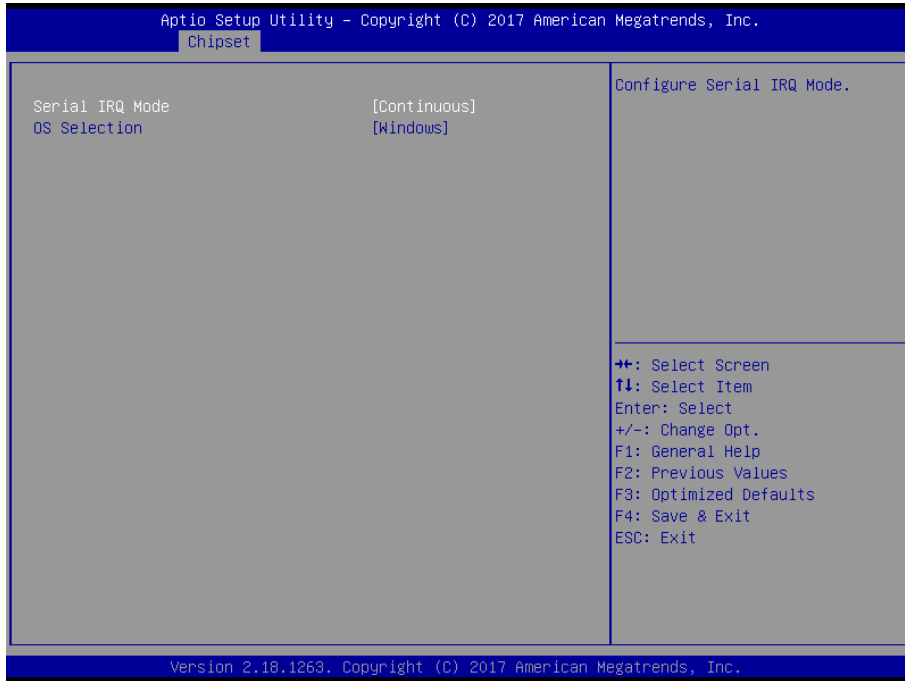

Item	Option	Description
Serial IRQ Mode	Quiet Continuous[Default]	Configure Serial IRQ Mode.
OS Selection	Windows[Default] Android Intel Linux	Select the target OS.

3.6.3.3 Uncore Configuration

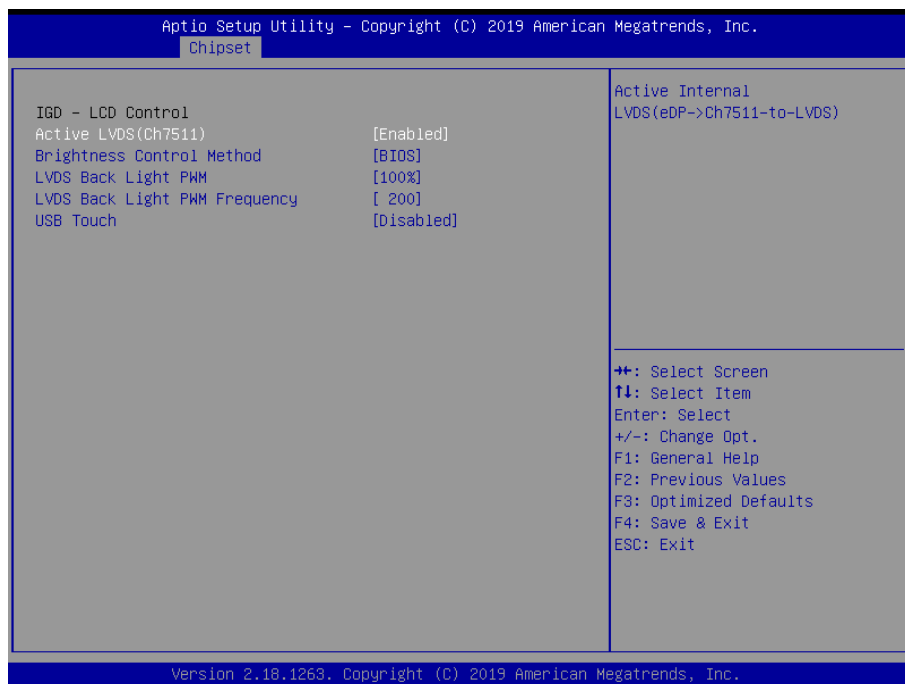

Quick Reference Guide

Item	Option	Description
Active LVDS (Ch7511)	Disabled[Default] Enabled	Active Internal LVDS(eDP->Ch7511-to-LVDS).
Brightness Control Method	BIOS[Default] BR Button VR OS Driver	LVDS Brightness Control Method. 1.BIOS 2.Brightness Button 3.Variable Resistor 4.OS Driver.
LVDS Back Light PWM	00% 25% 50% 75% 100%[Default]	Select LVDS back light PWM duty.
LVDS Back Light PWM Frequency	200[Default] 300 400 500 700 1k 2k 3k 5k 10k 20k	Select LVDS back light PWM Frequency.
USB Touch	Disabled[Default] Enabled	Enable or Disable USB Touch.

3.6.3.4 South Cluster Configuration

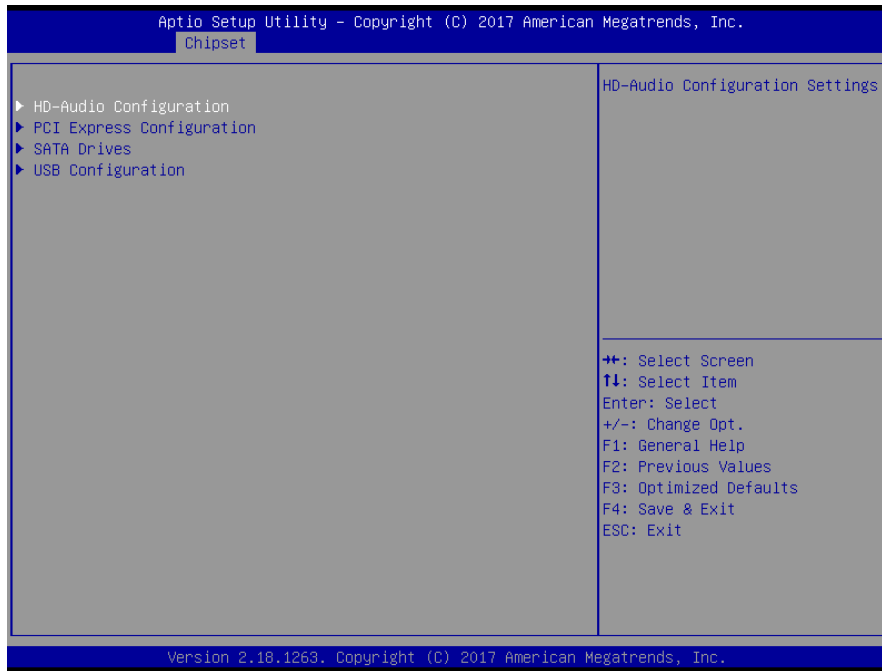

3.6.3.4.1 HD-Audio Configuration

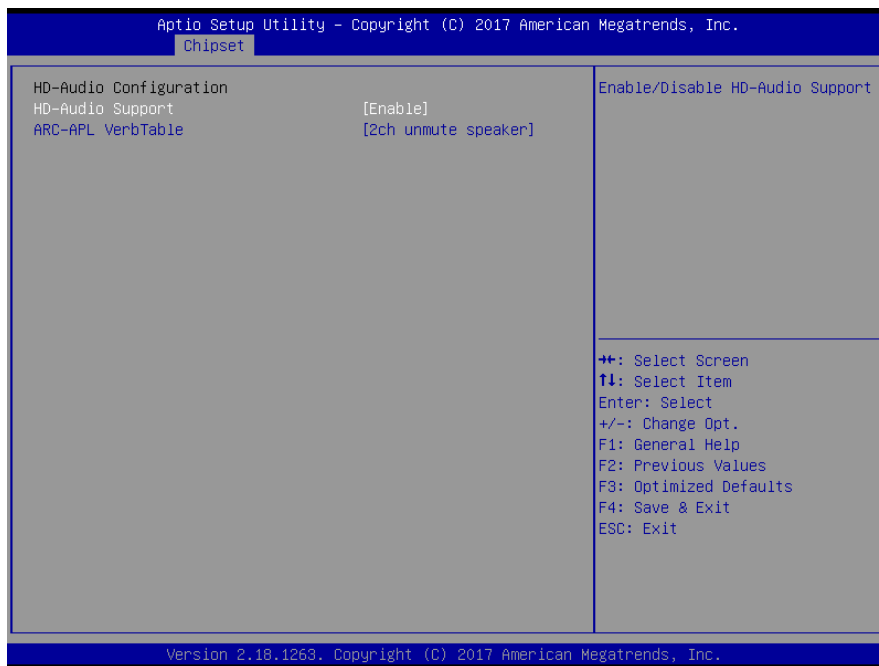

Item	Option	Description
HD-Audio Support	Disable[Default], Enable	Enable/Disable HD-Audio Support.
ARC-APL VerbTable	5.1ch 2ch unmute speaker[Default]	ARC-APL VerbTable.

3.6.3.4.2 PCI Express Configuration

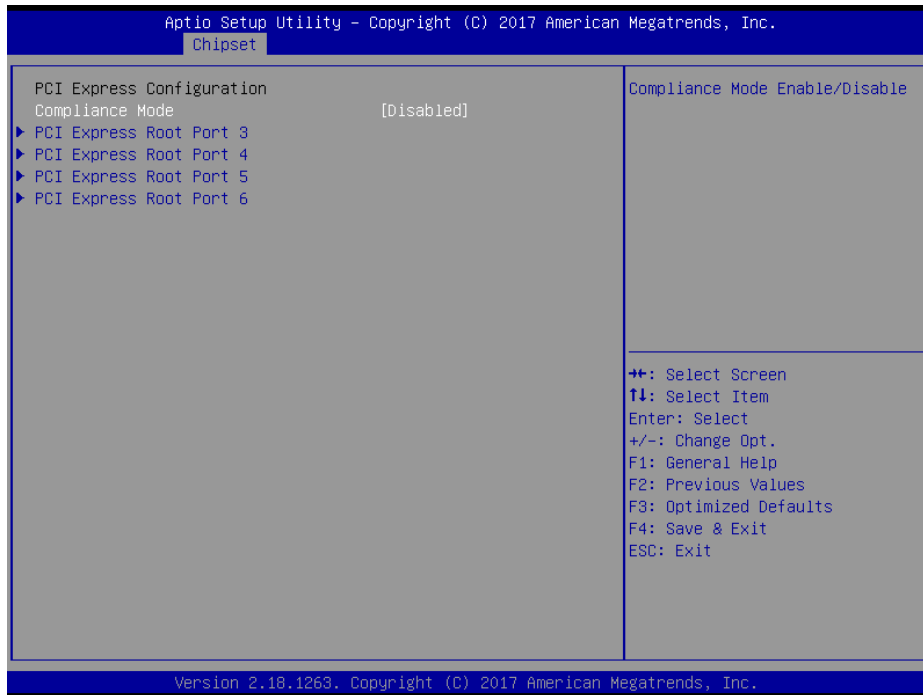

Item	Option	Description
Compliance Mode	Disable[Default], Enable	Compliance Mode Enable/Disable.

3.6.3.4.2.1 PCI Express Root Port 3

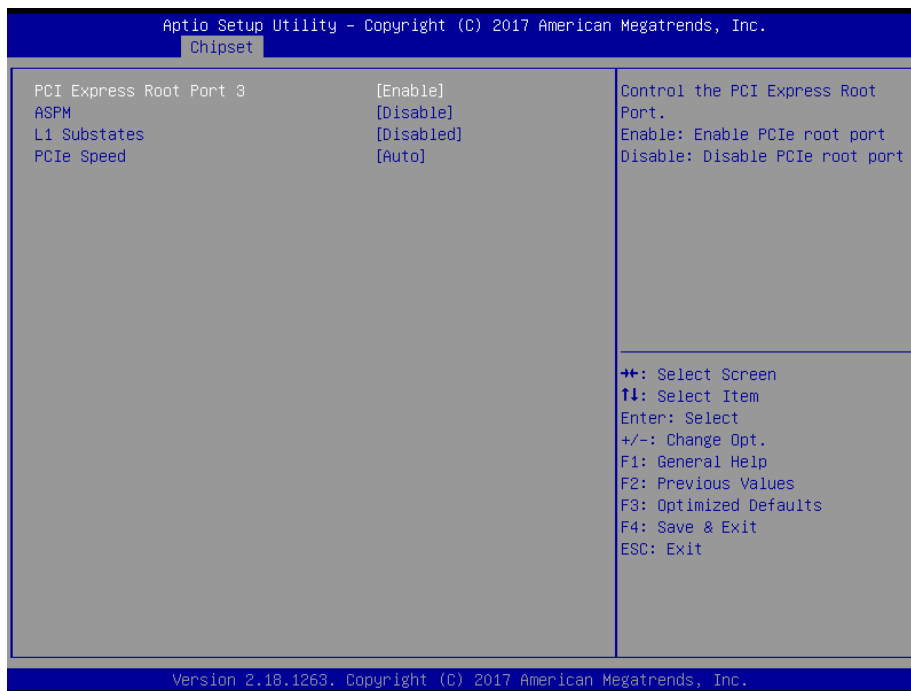

Item	Option	Description
PCI Express Root Port 3	Disable Enable[Default]	Control the PCI Express Root Port. Enable: Enable PCIe root port Disable: PCIe root port.
ASPM	Disable[Default] L0s L1 L0sL1 Auto	PCI Express Active State Power Management settings.
L1 Substates	Disabled[Default] L1.1 L1.2 L1.1 & L1.2	PCI Express L1 Substates settings.
PCIe Speed	Auto[Default] Gen 1 Gen 2	Configure PCIe Speed.

3.6.3.4.2.2 PCI Express Root Port 4

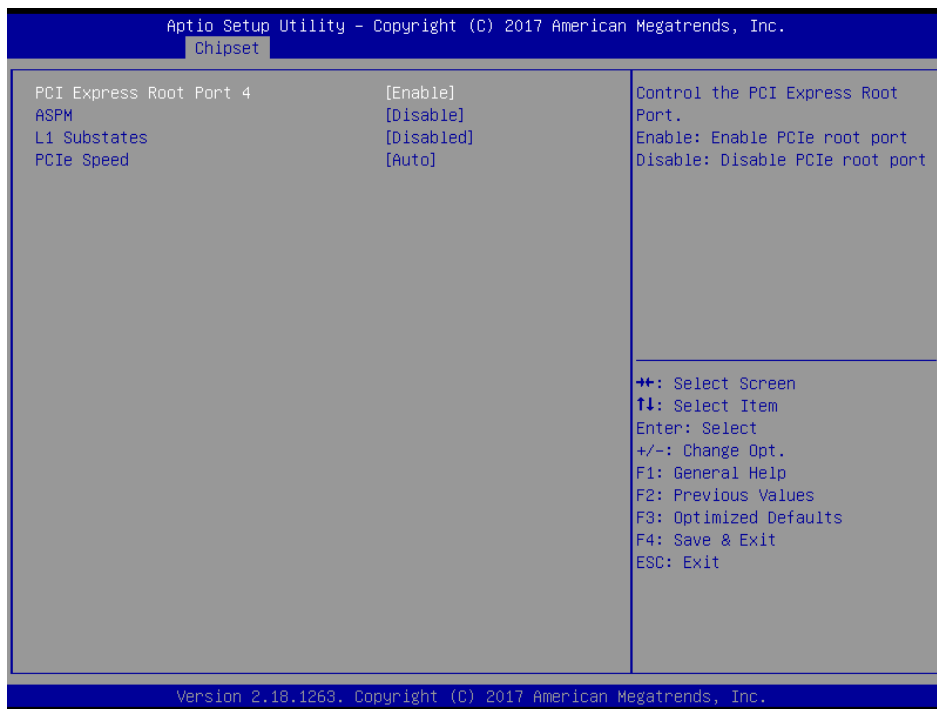

Item	Option	Description
PCI Express Root Port 4	Disable Enable[Default]	Control the PCI Express Root Port. Enable: Enable PCIe root port Disable: PCIe root port.
ASPM	Disable[Default] L0s L1 L0sL1 Auto	PCI Express Active State Power Management settings.

L1 Substates	Disabled[Default] L1.1 L1.2 L1.1 & L1.2	PCI Express L1 Substates settings.
PCIe Speed	Auto[Default] Gen 1 Gen 2	Configure PCIe Speed.

3.6.3.4.2.3 PCI Express Root Port 5

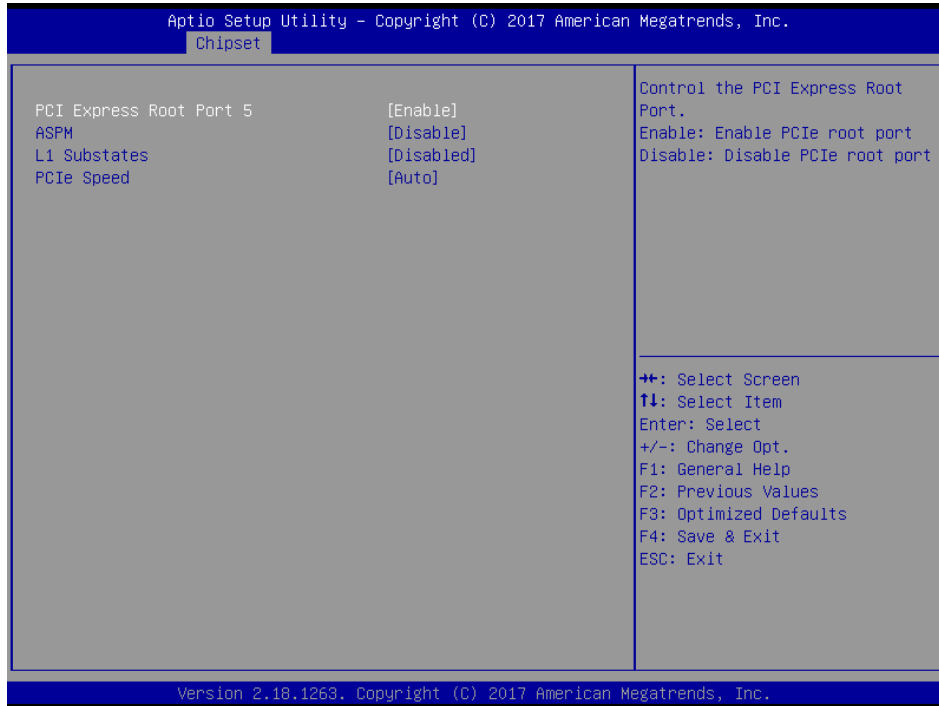

Item	Option	Description
PCI Express Root Port 5	Disable Enable[Default]	Control the PCI Express Root Port. Enable: Enable PCIe root port Disable: PCIe root port.
ASPM	Disable[Default] L0s L1 L0sL1 Auto	PCI Express Active State Power Management settings.
L1 Substates	Disabled[Default] L1.1 L1.2 L1.1 & L1.2	PCI Express L1 Substates settings.
PCIe Speed	Auto[Default] Gen 1 Gen 2	Configure PCIe Speed.

3.6.3.4.2.4 PCI Express Root Port 6

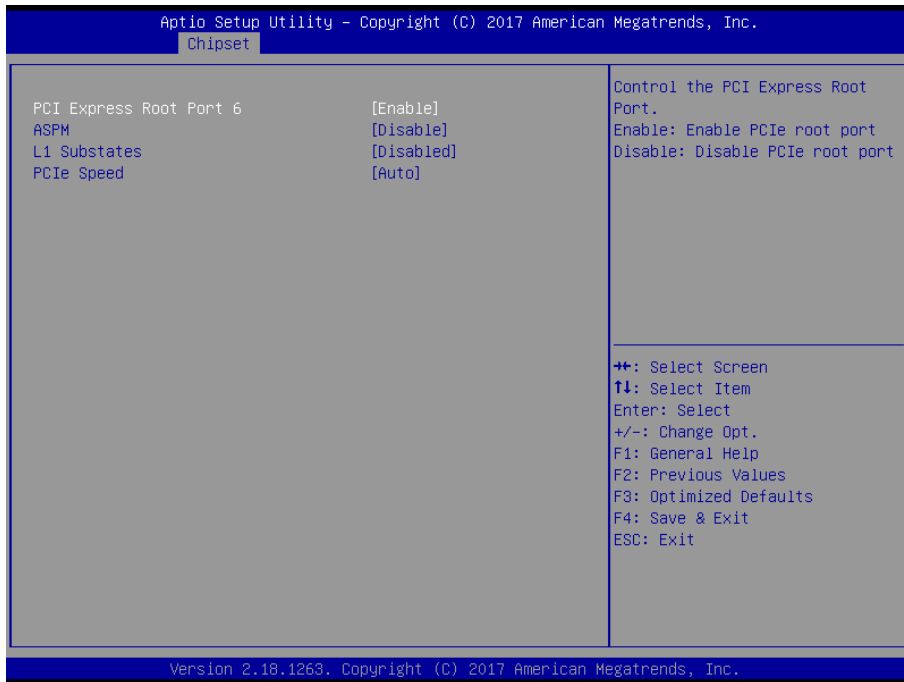

Item	Option	Description
PCI Express Root Port 6	Disable Enable[Default]	Control the PCI Express Root Port. Enable: Enable PCIe root port Disable: PCIe root port.
ASPM	Disable[Default] L0s L1 L0sL1 Auto	PCI Express Active State Power Management settings.
L1 Substates	Disabled[Default] L1.1 L1.2 L1.1 & L1.2	PCI Express L1 Substates settings.
PCIe Speed	Auto[Default] Gen 1 Gen 2	Configure PCIe Speed.

BIOS settings for Disabled LAN1/LAN2 Function

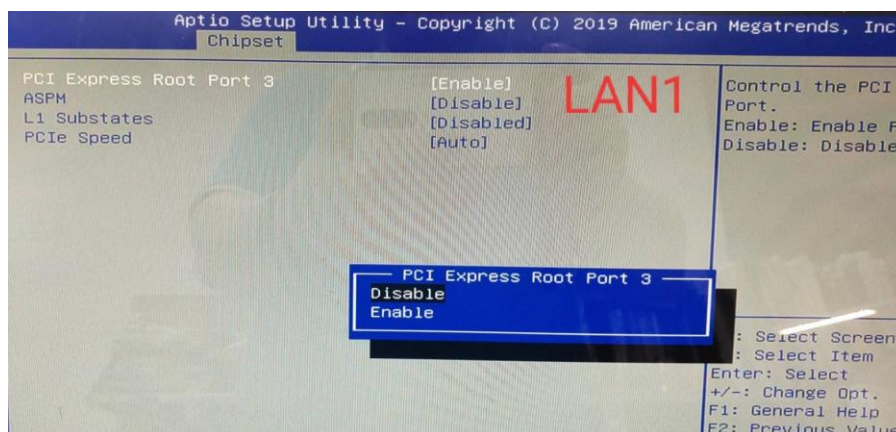
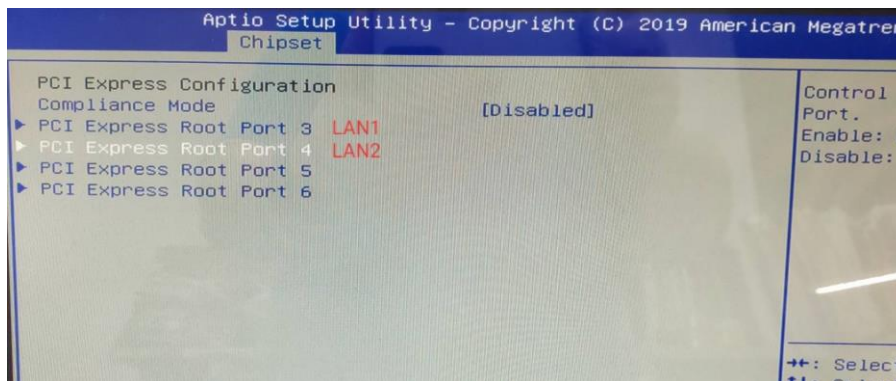
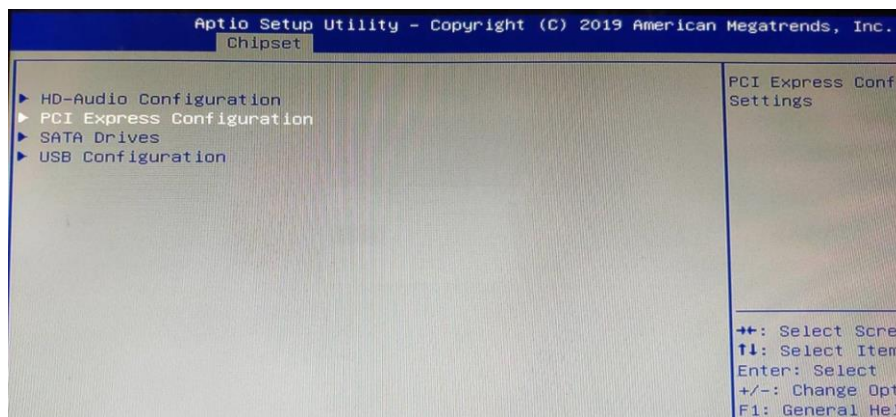
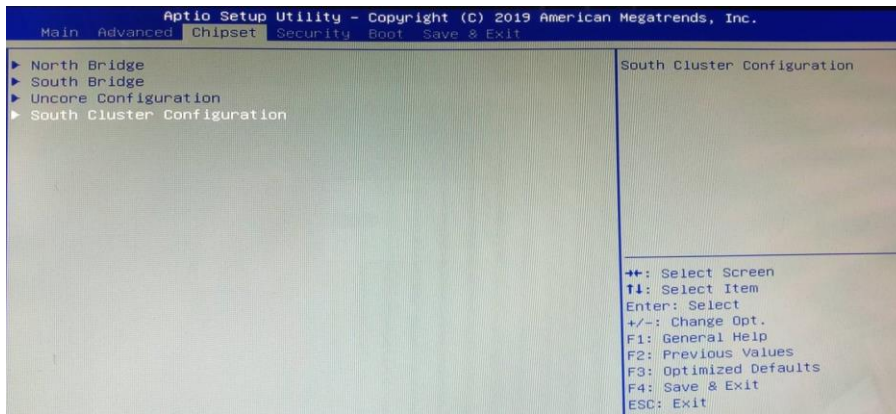

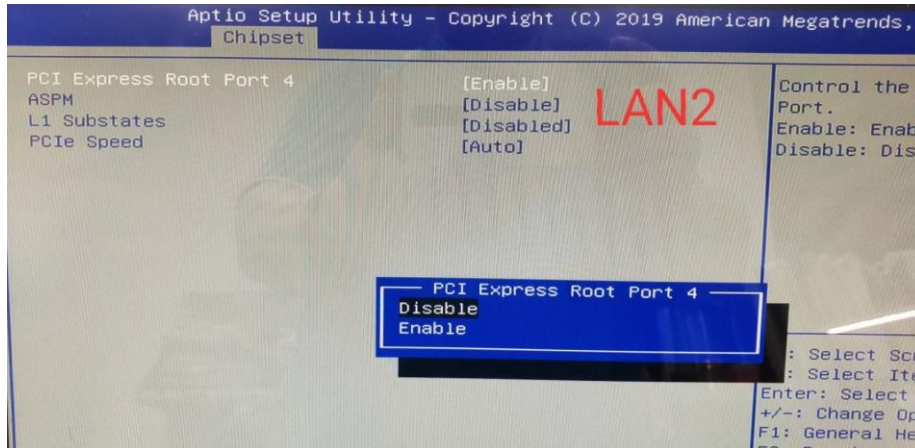

3.6.3.4.4 SATA Drives

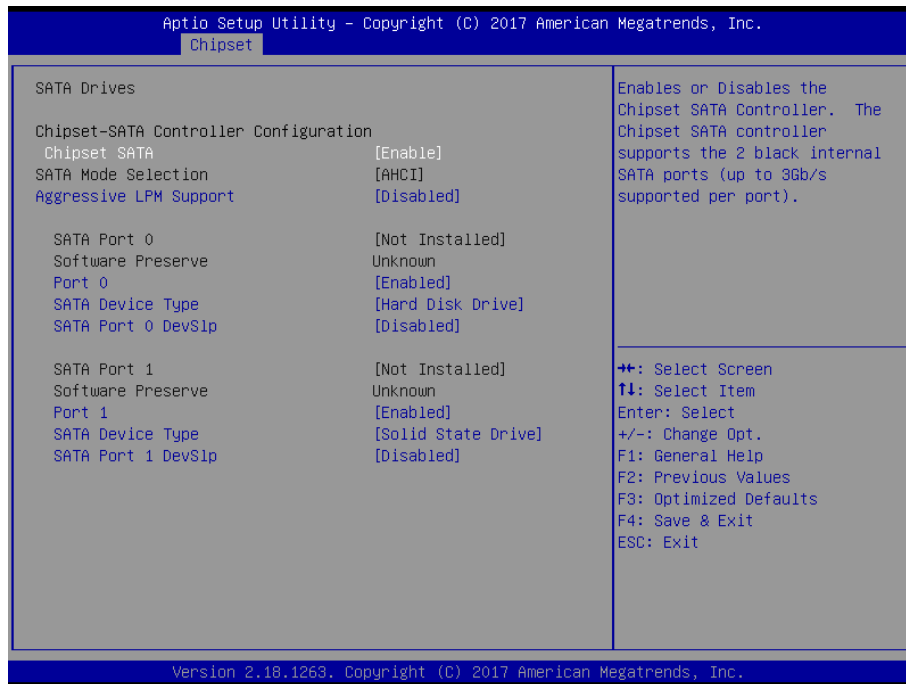

Item	Option	Description
Chipset SATA	Enable[Default], Disable	Enables or Disables the Chipset the SATA Controller. The Chipset SATA controller supports the 2 black internal SATA ports (up to 3Gb/s supported per port).
Aggressive LPM Support	Disabled[Default] Enabled	Enable PCH to aggressively enter link power state.
Port 0/1	Disabled Enabled[Default]	Enable or Disable SATA Port.
SATA Device Type	Hard Disk Drive[Default] Solid State Drive	Identify the SATA port is connected to Solid State Driver or Hard Disk Drive.
SATA Port 0/1 DevSlp	Disabled[Default] Enabled	Enable/Disable SATA Port 0/1 DevSlp. Board rework for LP needed before enable.

3.6.3.4.3 USB Configuration

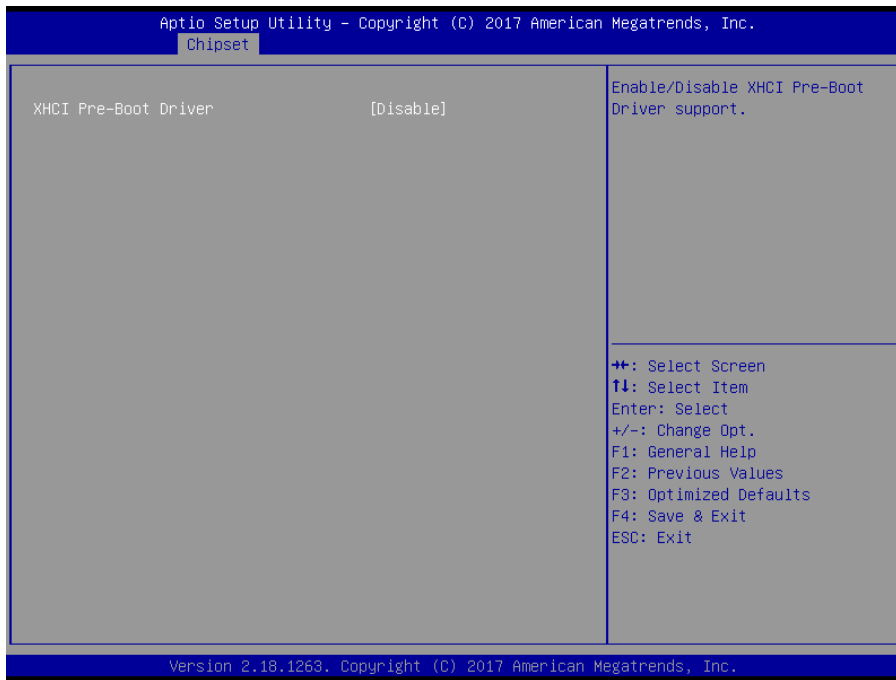

Item	Option	Description
XHCI Pre-Boot Driver	Enable, Disable[Default]	Enable/Disable XHCI Pre-Boot Driver support.

3.6.4 Security

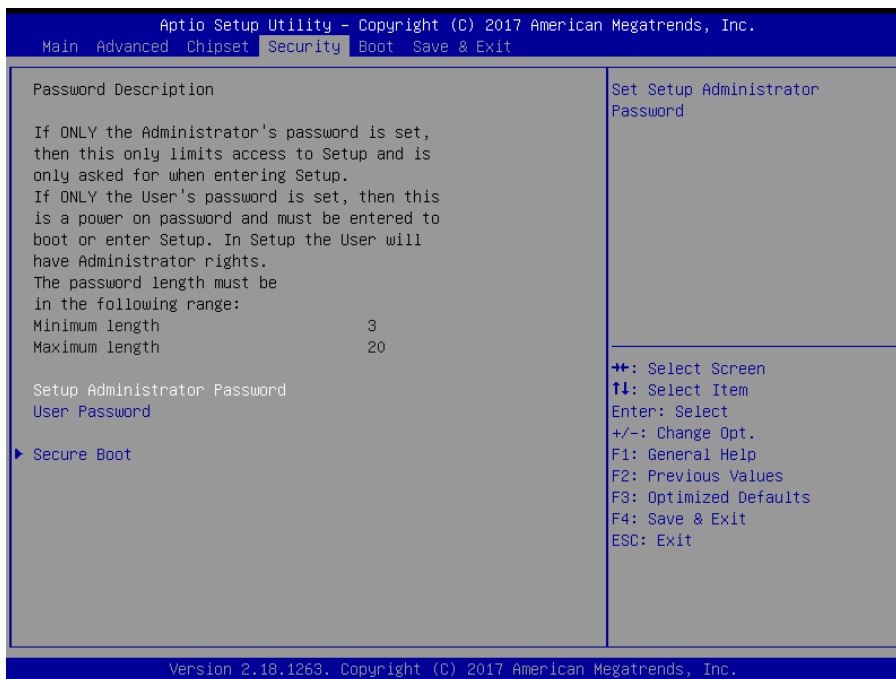

ARC-10W33

- **Administrator Password**

Set setup Administrator Password

- **User Password**

Set User Password

3.6.4.1 Secure Boot menu



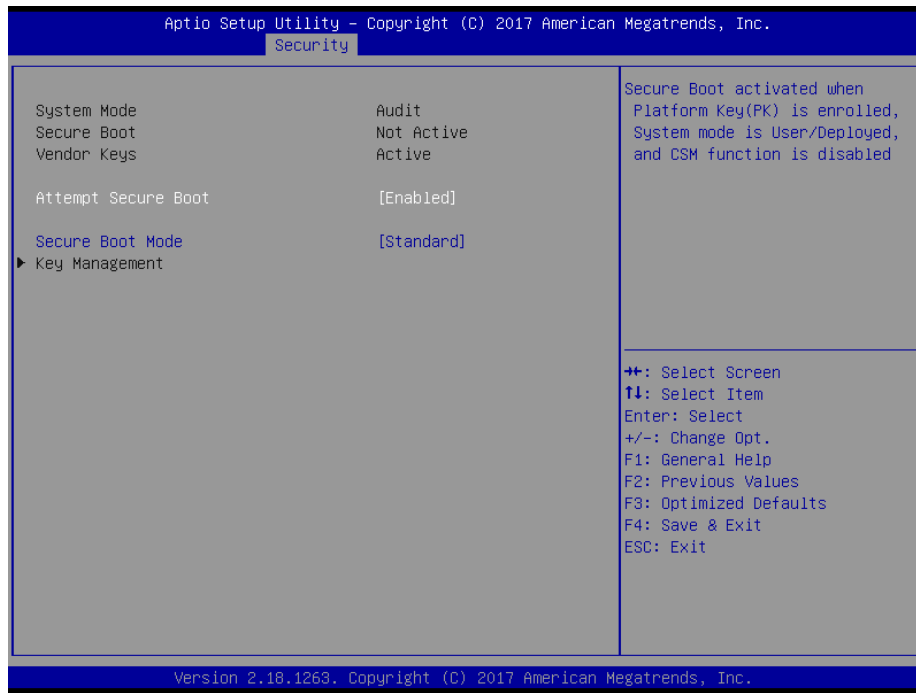

Item	Option	Description
Attempt Secure Boot	Disabled Enabled[Default]	Secure Boot activated when Platform Key(PK) is enrolled, System mode is User/Deploys, and CSM function is disabled.
Secure Boot Mode	Disabled[Default] Enabled	Secure Boot Mode – Custom_Standard, Set UEFI Secure Boot Mode to STANDARD mode or CUSTOM mode, this change is effect after save. And after reset, the mode will return to STANDARD mode.

3.6.5 Boot

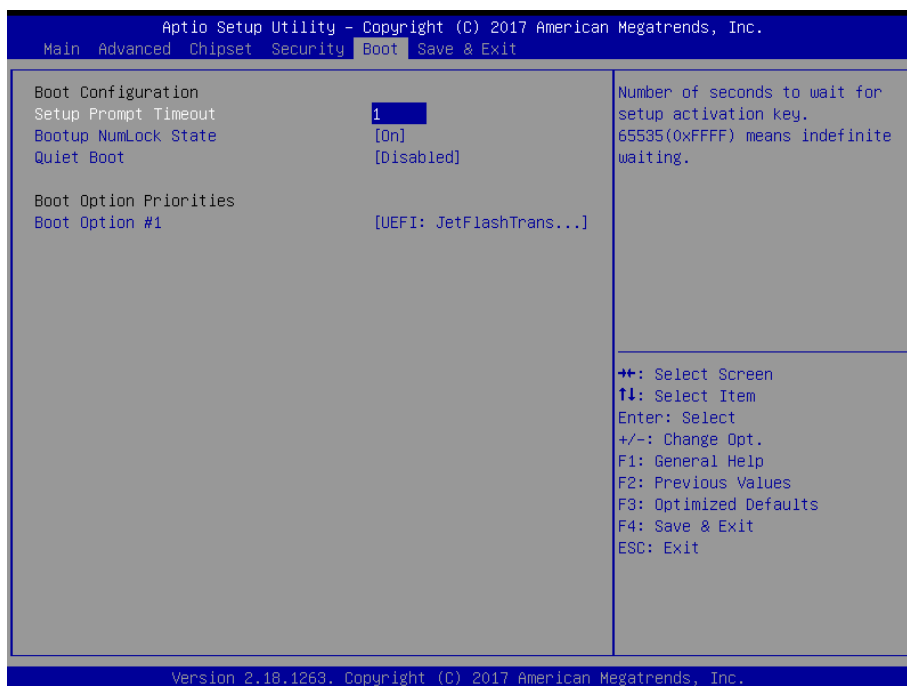

ARC-10W33

Item	Option	Description
Setup Prompt Timeout	1~ 65535	Number of seconds to wait for setup activation key. 65535(0xFFFF) means indefinite waiting.
Bootup NumLock State	On[Default] Off	Select the Keyboard NumLock state
Quiet Boot	Disabled[Default] Enabled	Enables or disables Quiet Boot option
Boot Option #1	Set the system boot order.	

3.6.6 Save and exit



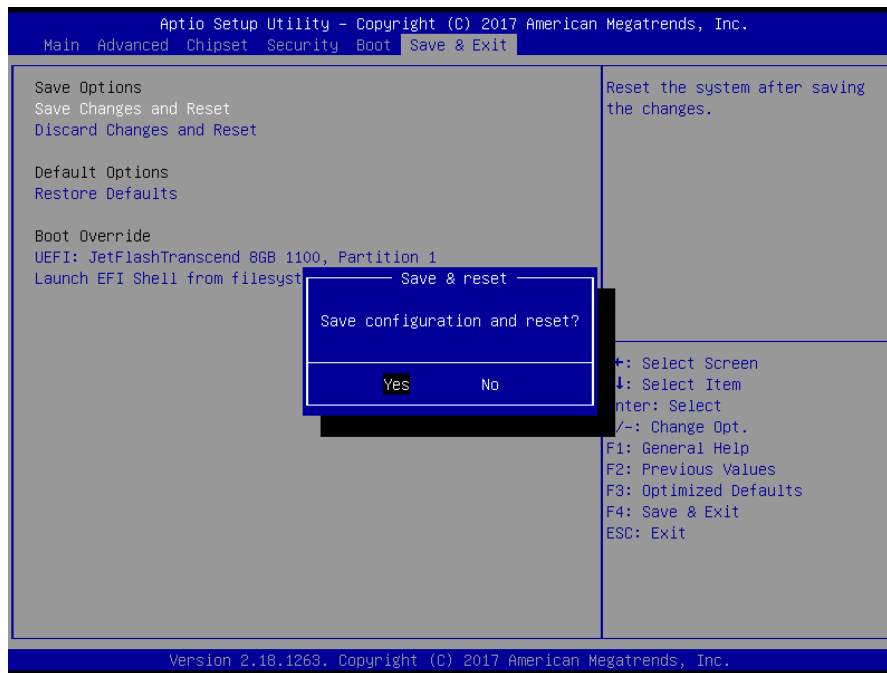

3.6.6.1 *Save Changes and Reset*

Reset the system after saving the changes.

3.6.6.2 *Discard Changes and Reset*

Any changes made to BIOS settings during this session of the BIOS setup program are discarded. The setup program then exits and reboots the controller.

3.6.6.3 *Restore Defaults*

This option restores all BIOS settings to the factory default. This option is useful if the controller exhibits unpredictable behavior due to an incorrect or inappropriate BIOS setting.

3.6.6.4 *Launch EFI Shell from filesystem device*

Attempts to Launch EFI Shell application (Shellx64.efi) from one of the available filesystem devices.

